

Item Number: 6109-0000**Item Description: 976nm, wavelength stabilized 25W, 200µm fiber-coupled module**

Parameter	Units	Minimum	Typical	Maximum
Optical				
CW Output Power from Fiber	W	25		
Center Wavelength	nm	974.5	976	977.5
Spectral Width (FWHM)	nm			0.7
Fiber Core Diameter	µm		200	
Fiber NA	-		0.22	
Temperature tuning coefficient	nm/°C		0.09	
Electrical (FCA)				
Operating Current (I _{OP})	A		40	45
Operating Voltage (V _{OP})	V		1.6	1.7
E-O conversion efficiency	%		40	
Thermal				
Operating Temperature	°C	20	25	30
Storage Temperature	°C	-20		70
Mechanical				
Module dimensions	mm		88 x 40 x 36	
Fiber length	m		2	
Fiber Input connector	-		HPSMA 905	
Thermistor				
Type	-		NTC	
Resistance at 25°C	KΩ		10	
Optional Aiming Beam				
Wavelength	nm			635 +/- 10
Optical power	mW			>=1.0
Optional Monitoring Photo Diode				
Output signal at full power	µA	50		250
Control signal				
Interfacing	DB-15 connector at module back wall			

Notes

1. Performance to be tested at 25C module base plate temperature
2. Non-condensing operating environment required

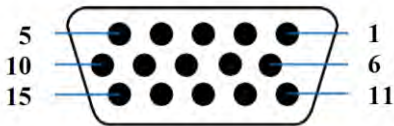
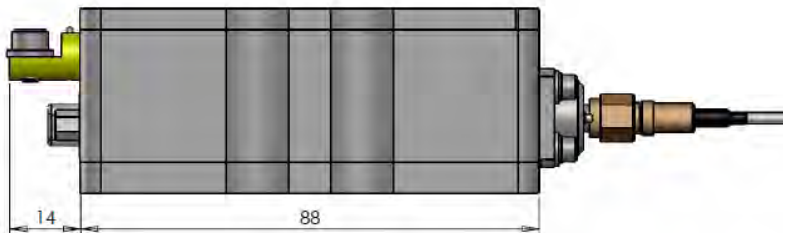
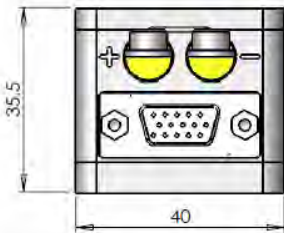
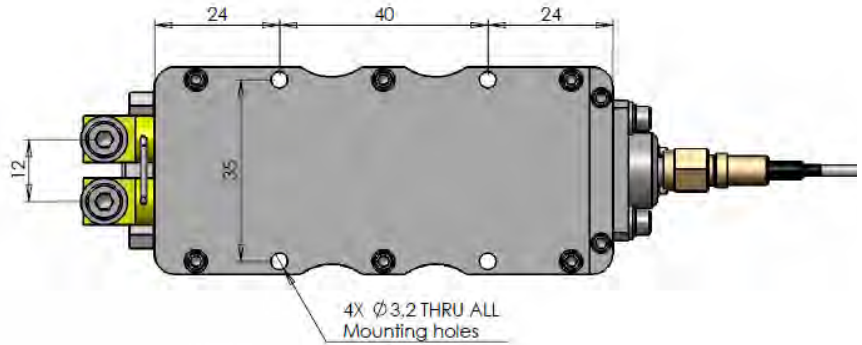

Pin number	Assignment
1	Not used
2	Not used
3	Aiming beam "+"
4	Aiming beam Ground
5	Monitor Photodiode "+"
6	Monitor Photodiode "-"
7	Not used
8	Not used
9	Not used
10	Not used
11	Not used
12	Not used
13	Not used
14	Thermistor (NTC)
15	Thermistor (NTC)

