

1064nm, 400µm, Conduction-Cooled, Single Bar, Fiber-Coupled Module

Features

- High coupling efficiency
- High brightness
- Sealed housing
- Standard fiber coupling (HP-SMA) for 400µm NA 0.22



Device Specification

Optical Parameters ¹	Units	
Center Wavelength Range ³	nm	1064
Center Wavelength Tolerance	nm	±10
Output Power ²	W	30
Spectral Width (FWHM)	nm	<7
Slope Efficiency	W/A	>0.7
Wavelength Temp. Coefficient	nm/°C	~0.40

Fiber Parameters		
Numerical Aperture	NA	0.22
Fiber Core Diameter	µm	400
Fiber Connector		HP-SMA 905 with Free Standing Fiber Tips

Electrical Parameters ¹		
Power Conversion Efficiency	%	>40
Threshold Current (I_{TH})	A	<7
Operating Current (I_{OP})	A	<57
Operating Voltage (V_{OP})	V	<1.7

Thermal Parameters		
Operating Temperature ^{3, 4}	°C	+20 to +30
Storage Temperature ⁴	°C	0 to +55
Recommended Heatsink Capacity	W	>70

Optional

True unpolarized output is available as an option.

¹Data at 25°C cold plate temperature.

²Reduced lifetime if used above nominal operating conditions.

³Others available upon request.

⁴A non-condensing environment is required for storage and operation below the ambient dew point.

1064nm, 400µm, Conduction-Cooled, Single Bar, Fiber-Coupled Module

Package Dimension

Module M1F-SS2.1

(Optional monitor photo diode and temperature sensor/NTC)

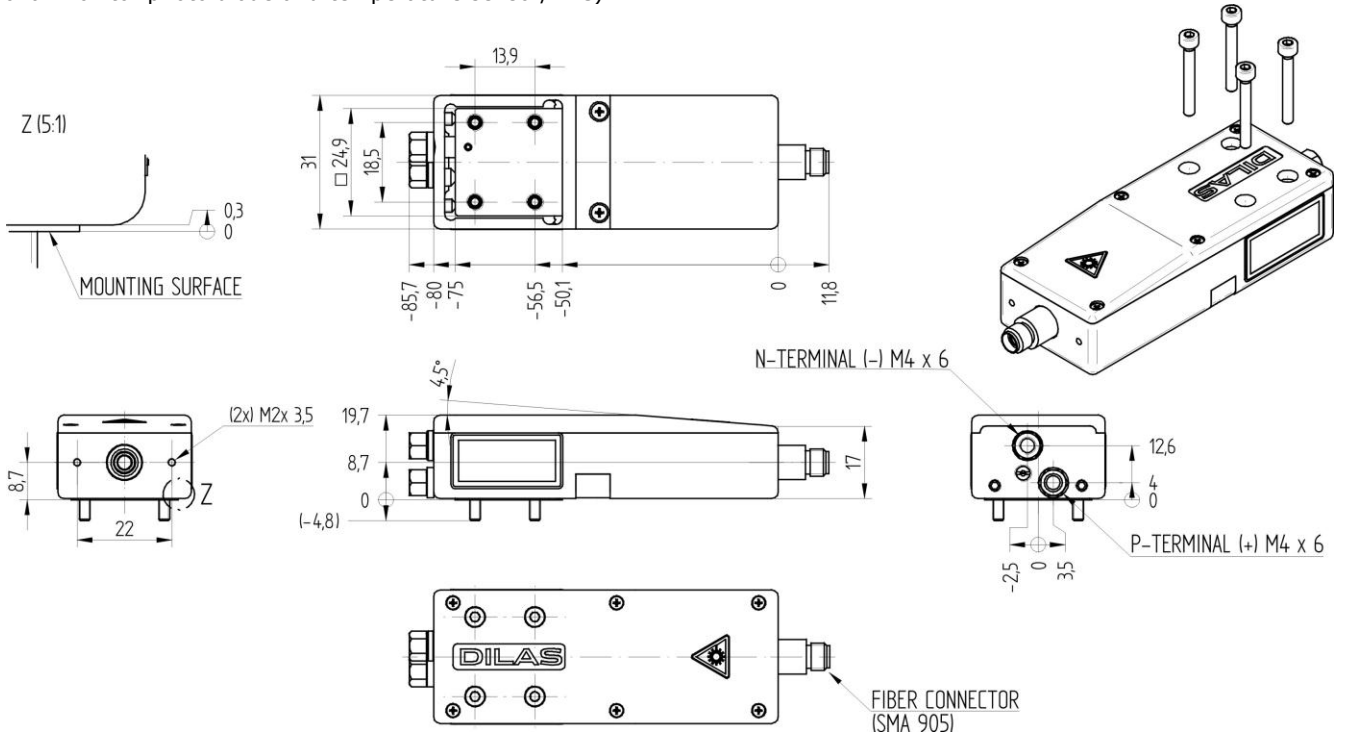

Module M1F-SS5.2

(Includes pointer, monitor photo diode, temperature sensor/NTC and fiber interlock)

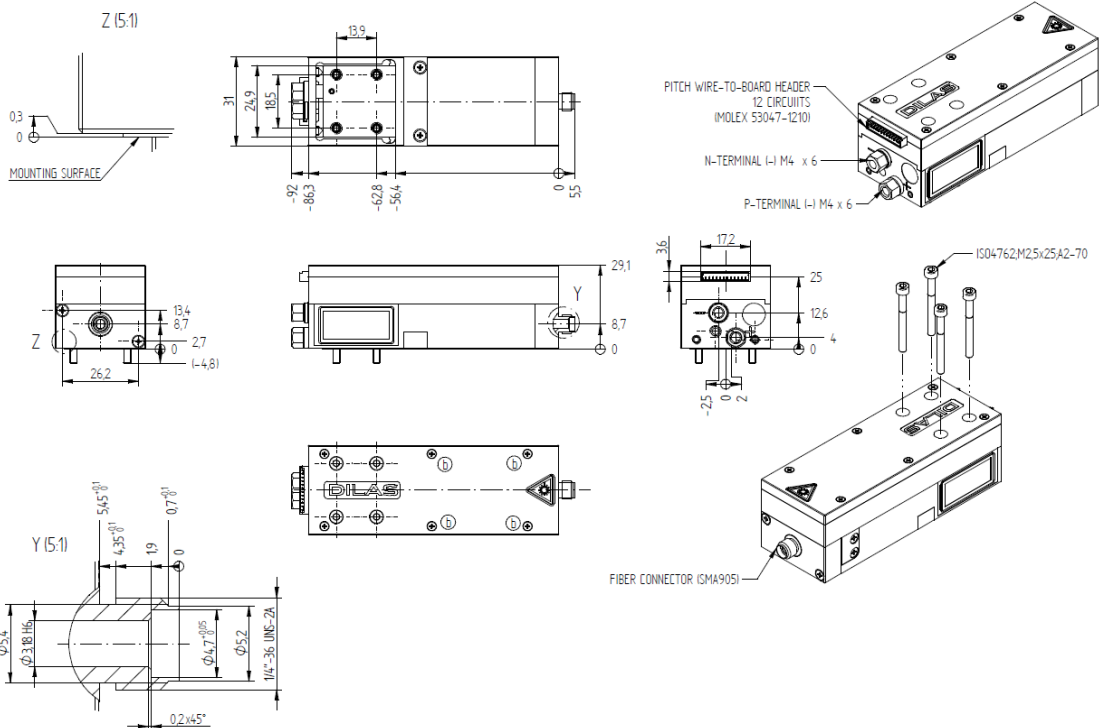

©2012 DILAS. All rights reserved. DILAS reserves the right to change product specifications without notice. For handling precautions, please reference the general handling instruction manual.

For complete details, please contact your local DILAS sales representative or visit our website at www.DILAS.com.

Europe
DILAS Diodenlaser GmbH
Galileo-Galilei-Straße 10
55129 Mainz
Germany
Phone: +49 (6131) 9226 0
Fax: +49 (6131) 9226 257
Email: sales@DILAS.de

North America
DILAS Diode Laser, Inc.
9070 South Rita Road
Suite 1500
Tucson, AZ 85747
Phone: +1 (520) 232-3484
Fax: +1 (520) 232-3499
Email: sales@DILAS-INC.com

Asia
DILAS Diodenlaser GmbH
China Sales Office
Room 206, Sunplus Technology, Bldg. 2
No. 1077 Zu Chongzhi Road
Hi-Tech Park, Shanghai 201203,
P.R. China
Phone: +86 (0) 21-6855-2216
Fax: +86 (0) 21-5027-3793
Email: sales@dilas-china.com.cn