

MDL-E-520/1~10mW



**NARROW LINEWIDTH
DIODE LASER AT 520 nm**

Narrow linewidth diode laser module at 520nm is made features of narrow spectral linewidth, stable wavelength, long lifetime and easy operating, which is widely used in precision measurement, high resolution spectrum analysis, etc.



SPECIFICATIONS

Wavelength (nm)	520±5
Operating mode	CW
Output power (mW)	>1, 2, 3, ...,10
Power stability (rms, over 4 hours)	<1%, <3%, <5%
Transverse mode	Near TEM ₀₀
Spectral linewidth (nm)	<0.06, <0.03(extra heatsink)
M ² factor	<1.5
Beam diameter at the aperture (1/e ² ,mm)	~3.0
Beam divergence, full angle (mrad)	<1.0
Polarization ratio	>50:1 (>100:1, optional) Horizontal ±5 degree (Vertical Optional)
Warm-up time (minutes)	<15
Beam height from base plate (mm)	30
Operating temperature (°C)	20~30
Power supply (85-264VAC)	PSU-III-FDA
Expected lifetime (hours)	10000
Warranty	1 year



MDL-E-520

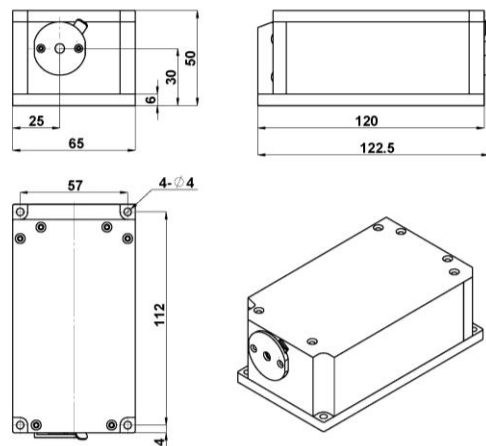

122.5(L) ×65(W) ×50 (H) mm³, 1.0kg

PSU-III-FDA

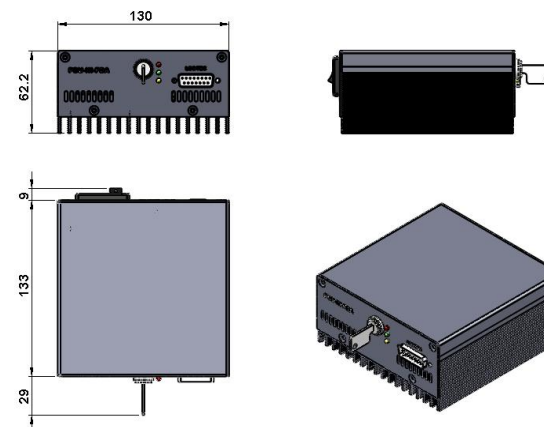

171(L) ×130(W) ×62.2 (H) mm³, 1.2kg