

Blue Laser Diode for External Cavity

NDBA116T

Test Sample

■ Features

- For External Cavity Laser with Low Reflection Coating on front facet
- Optical Output Power: 30mW (Pulse)
- Can Type: ϕ 5.6 mm Floating Mounted with Photo Diode and Zener Diode

■ Absolute Maximum Ratings

(Pulse *1)

Item	Symbol	Absolute Maximum Ratings	Unit
Optical Output Power	Po	45	mW
LD Forward Current	If	280	mA
Allowable Reverse Current	Ir (LD)	85	mA
PD Reverse Voltage	Vr (PD)	20	V
Storage Temperature	Tstg	-25 ~ 75	°C
Operating Case Temperature	Tc	10 ~ 30	°C

 *Pulse Condition: Pulse Width 2.5 μ s, Duty 5%

■ Initial Electrical/Optical Characteristics

(Pulse*1 Ta=23°C *2)

Item	Condition	Symbol	Min	Typ.	Max	Unit	
Optical Output Power	Pulse	Po	-	-	30	mW	
Peak Wavelength	Po=30mW	λ_p	450	-	455	nm	
Threshold Current	Pulse	Ith	-	210	-	mA	
Operating Current	Po=30mW	Iop	-	230	-	mA	
Slope Efficiency	Pulse	η	-	1.5	-	W/A	
Operating Voltage	Po=30mW	Vop	-	7.1	-	V	
Beam Divergence*3	Po=30mW	$\theta_{//}$	7	-	12	deg.	
		θ_{\perp}	15	-	25	deg.	
Emission Point Accuracy	Angle	Po=30mW	$\Delta\theta_{//}$	-2.0	-	2.0	deg.
			$\Delta\theta_{\perp}$	-3.0	-	3.0	deg.
Monitor Current*4	Po=30mW	Im	-	-	1	mA	

 *1 The Laser can NOT be lasing under CW operating without External Cavity. Pulse 0.5 μ s, Duty 20%

*2 There is some range in ambient temperature. *3 Full angle at 50% from peak intensity.

*4 Monitor Current is short time power reference purpose only. Not guaranteed for accuracy. This value must be affected intensely by feedback from composing optics.

All figures in this specification are measured by Nichia's method and may contain measurement deviations.
Diffraction feedback efficiency to the Laser diode must be limited less than 30 % under the External cavity configuration.
This model can only be performed under CW operating with External Cavity.
This model is Test Sample for evaluation or design purpose only. Life time is not guaranteed.
The above specifications are for reference purpose only and subjected to change without prior notice.

Safety of Laser light

- **Laser Light can damage the human eyes and skin.** Do not expose the eye or skin to any laser light directly and/or through optical lens. When handling the LDs, wear appropriate safety glasses to prevent laser light, even any reflections from entering to the eye. Focused laser beam through optical instruments will increase the chance of eye hazard.
- These LDs are classified in **Class 4 of IEC60825-1 and 21 CFR Part 1040.10 Safety Standards.** It is absolutely necessary to take overall safety measures against User's modules, equipment and systems into which Nichia LDs are incorporated and/or integrated.

Outline Dimension

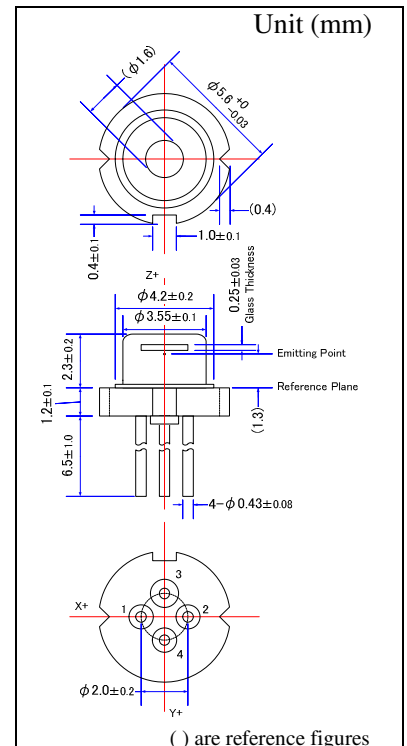

Pin Connection

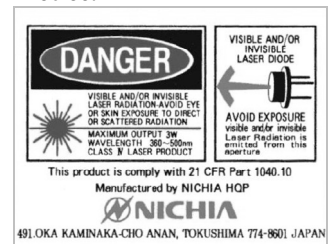
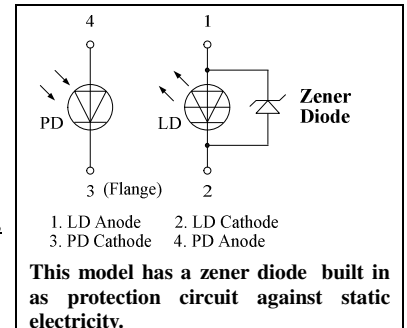

NICHIA CORPORATION

<http://www.nichia.co.jp>

◆ HEADQUARTERS

 491 Oka, Kaminaka-Cho, Anan-Shi, TOKUSHIMA 774-8601, JAPAN
 PHONE: +81-884-22-2311 FAX: +81-884-21-0148

◆ CONTACT

TOKYO SALES OFFICE

 13F Tamachi Center Building 34-7, Shiba 5-Chome, Minato-Ku, TOKYO 108-0014, JAPAN
 PHONE: +81-3-3456-3108 FAX: +81-3-5440-7330

Typical Initial Electrical/Optical Characteristics

Optical Output Power vs. Forward Current (Pulse)

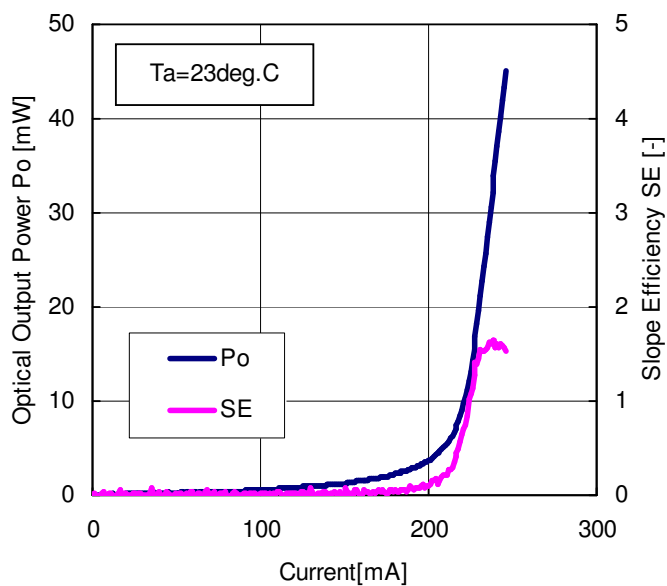

Forward Voltage vs. Forward Current (Pulse)

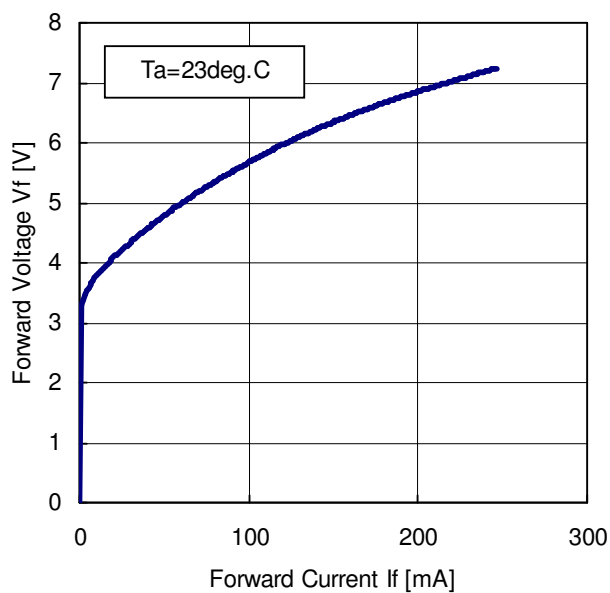

Far Field Pattern (Pulse)

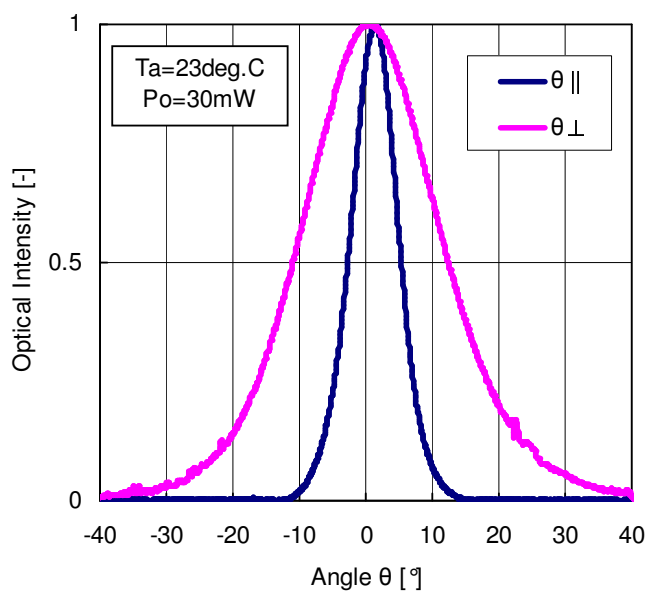

Spectrum (Pulse)

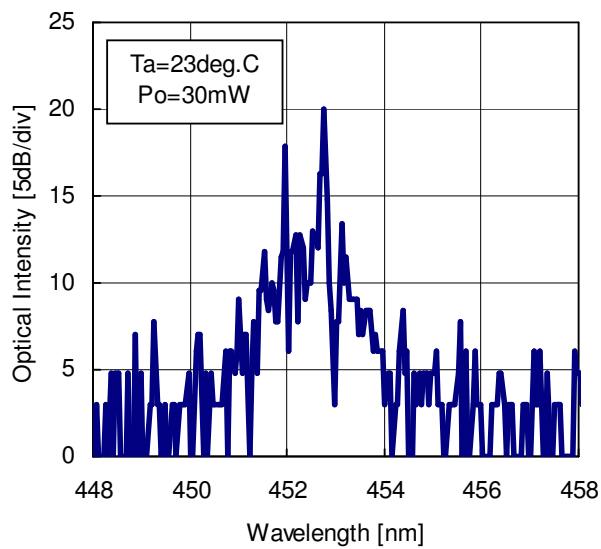

■ Cautions

(1) Operating method

- The LD shall change its forward voltage requirement and optical output power according to temperature change. Also, the LD will require more operation current to maintain same output power as it degrades.
- The use of heat sink is strongly recommended to reduce increases in temperature.
- Confirm that electrical spike current generated by switching on and off does not exceed the maximum operating current level specified herein above as absolute max rating. Also, employ appropriate countermeasures to reduce chattering and/or overshooting in the Circuit.

(2) Static Electricity

- Static electricity or electrical surges will reduce and degrade the reliability of the LDs. It is recommended to use a wrist strap or anti-electrostatic glove when handling the Product.

(3) Absolute Maximum Rating

- Active layer of LDs shall have high current density and generate high electric field during its operation. In order to prevent excessive damage, the LD must be operated strictly below Absolute Max Rating.

(4) Others

- Nichia LDs described in this brochure are intended to be used for ordinary electronic equipment (such as office equipment, communications equipment, measurement instruments and household appliances). Consult Nichia's sales staff in advance for information on the applications in which exceptional quality and reliability are required, particularly when the failure or malfunction of the LDs may directly jeopardize life or health (such as for airplanes, aerospace, submersible repeaters, nuclear reactor control systems, automobiles, traffic control equipment, life support systems and safety devices).
- The Purchaser must acknowledge that any LD can be failed statically and must design its equipments fail safe design. Prior to use of the LD, please confirm that the LD, as described in Nichia's specifications, meets the life expectancy needs of, and provides the features required by the Circuit and any related modules, equipment and/or systems.
- Nichia prohibit Purchaser from reverse engineering, disassembling, or taking any other steps to derive the structure or design of the LD.
- The appearance and specifications of the product may be modified for improvement without notice. The formal specifications must be exchanged and signed by both parties before large volume purchase begins.
- No unauthorized transmission or reproduction of this document, either in whole or in part, is permitted.