

940nm, 400µm, Conduction-Cooled, Fiber-Coupled Multi-Bar Module

Features

- Single wavelength
- High coupling efficiency
- Thermal interface by base-plate
- Scalable output power

Optional Accessories

- Integrated pointer laser
- Integrated power meter
- Integrated NTC temperature sensor
- Fiber detection sensor



Device Specification

Optical Parameters ¹	Units		
Center Wavelength Range ³	nm		940
Center Wavelength Tolerance	nm	±3	±3
Output Power ²	W	200	240
Spectral Width (FWHM)	nm	<5	<4
Slope Efficiency	W/A	>4.4	>5
Wavelength Temp. Coefficient	nm/°C	~0.34	~0.34

Fiber Parameters		
Numerical Aperture	NA	0.22
Fiber Core Diameter	µm	400
Fiber Connector		HP-SMA 905 with Free Standing Fiber Tips

Electrical Parameters ¹			
Power Conversion Efficiency	%	>40	>40
Threshold Current (I _{TH})	A	<8.5	<7.5
Operating Current (I _{OP})	A	<60	<60
Operating Voltage (V _{OP})	V	<12	<12

Thermal Parameters		
Operating Temperature ^{2, 3, 4} (Cooling Plate)	°C	+20 to +25
Operating Temperature ^{2, 3, 4} (Diode Laser Module)	°C	+30 to +35
Storage Temperature ^{3, 4}	°C	0 to +55
Coolant Flow Rate	l/h	250 to 400
Operating Water Temperature	°C	+20 to +25
Maximum Particle Size	µm	<10
Recommended Cooling Capacity	W	>480

¹Data at 25°C cold plate temperature, unless otherwise stated.

²Reduced lifetime if used above nominal operating conditions.

³Others available upon request.

⁴A non-condensing environment is required for storage and operation below the ambient dew point.

940nm, 400µm, Conduction-Cooled, Fiber-Coupled Multi-Bar Module

Package Dimension

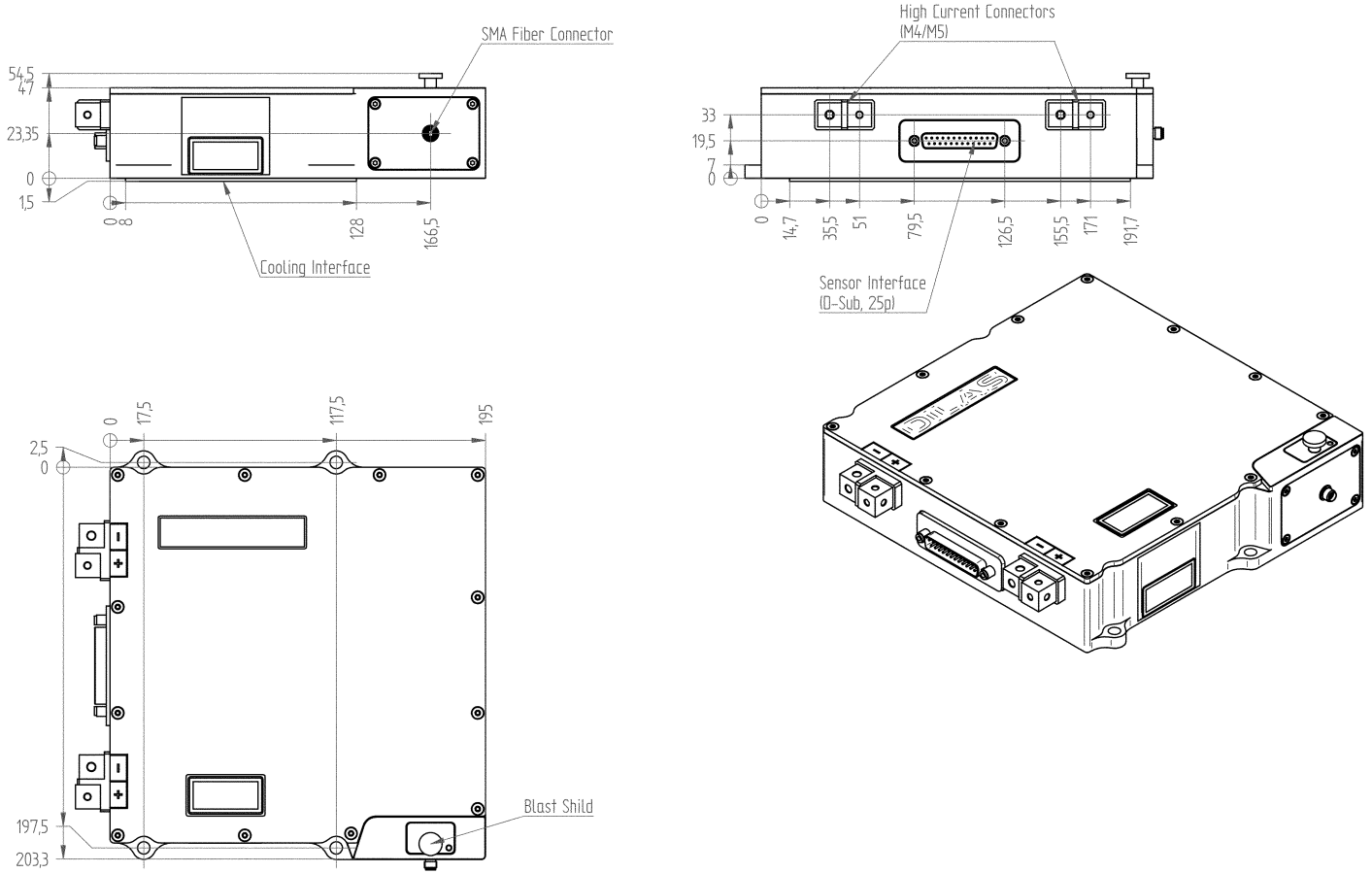

©2012 DILAS. All rights reserved. DILAS reserves the right to change products specifications without notice. For handling precautions, please reference the general handling instruction manual.

For complete details, please contact your local DILAS sales representative or visit our website at www.DILAS.com.

Europe
DILAS Diodenlaser GmbH
Galileo-Galilei-Straße 10
55129 Mainz
Germany
Phone: +49 (0)6131 9226 0
Fax: +49 (0)6131 9226 257
Email: sales@DILAS.de

North America
DILAS Diode Laser, Inc.
9070 South Rita Road
Suite 1500
Tucson, AZ 85747
Phone: +1 (520) 232-3480
Fax: +1 (520) 232-3499
Email: sales@DILAS-INC.com

China & Taiwan
DILAS Diodenlaser GmbH
China Sales Office
Room 206, Sunplus Technology, Bldg. 2
No. 1077 Zu Chongzhi Road
Hi-Tech Park, Shanghai 201203,
P.R. China
Phone: +86 (0) 21-6855-2216
Fax: +86 (0) 21-5027-3793
Email: sales@dilas-china.com.cn