

PART NUMBER: ARR189P200  
1-BAR A PACKAGE

### FEATURES AND BENEFITS

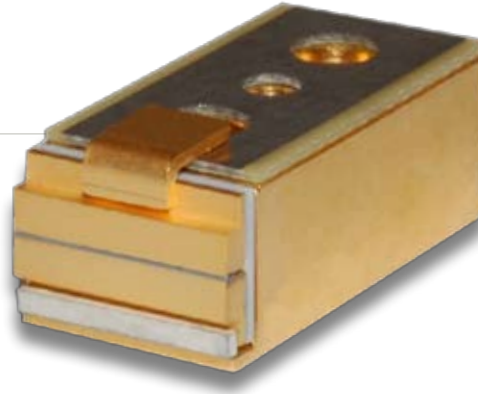

- Assembled With Hard Solder & Expansion Matched Materials
- Ideal For Long Pulse And/Or High Duty Cycle Applications
- Standard Bar Pitch Options Include 400  $\mu\text{m}$ , 800  $\mu\text{m}$ , & 1200  $\mu\text{m}$
- Available Wavelengths: 790-1550nm
- Multi-wavelength Configurations Available
- A Package Also Available With Up To 8 Bars For A Maximum Output Power Of 1.6 kW

### OPTICAL CHARACTERISTICS

Parameter	Conditions	Typical	Units
QCW Power Output	175A at 25°C Heat Sink	200	W
Operating Current	200W at 25°C Heat Sink	175	A
Threshold Current	25°C Heat Sink	15	A
Slope Efficiency	25°C Heat Sink	1.25	W/A
Electrical-Optical Efficiency	200W at 25°C Heat Sink	57	%
Center Wavelength	200W at 25°C Heat Sink	808	nm
Wavelength Tolerance	200W at 25°C Heat Sink	+/-3	nm
Spectral Width	200W at 25°C Heat Sink	3.0	nm
Wavelength Shift	—	0.25	nm/°C
Beam Divergence FWHM	—	38x7	x°
Beam Divergence FWHM (Lensed)	—	1x7	x°

### ELECTRICAL CHARACTERISTICS

Parameter	Conditions	Typical	Units
Series Resistance	25°C Heat Sink	0.002	$\Omega$
Operating Voltage	25°C Heat Sink, 200W	2.0	V

### ABSOLUTE MAXIMUM RATINGS

Parameter	Conditions
Reverse Current	0 A
Reverse Voltage	0 V
Operating Temperature Range	-40°C to 70°C
Storage Temperature Range	-40°C to 85°C

### NOTES

- (1) These specifications apply for operation at 808nm. Other wavelengths available upon request.
- (2) A dry nitrogen environment should be provided by the user when storing and operating at temperatures below ambient dew point.
- (3) Fast axis and slow axis lensing options are available for most NG-CEO heat exchanger designs.

## 200W QCW

**NORTHROP GRUMMAN**

### OPTICAL CHARACTERISTICS (SAMPLE)

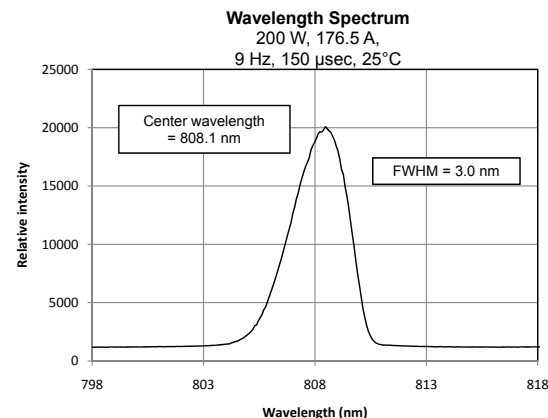
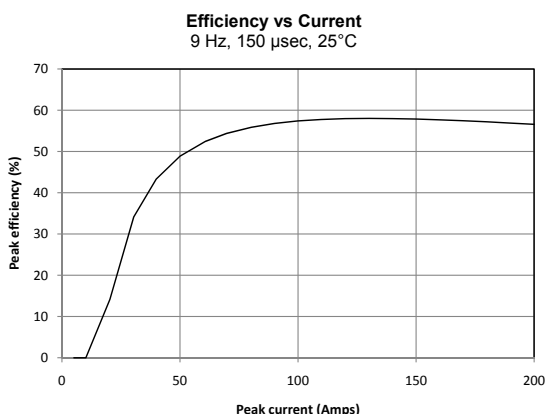
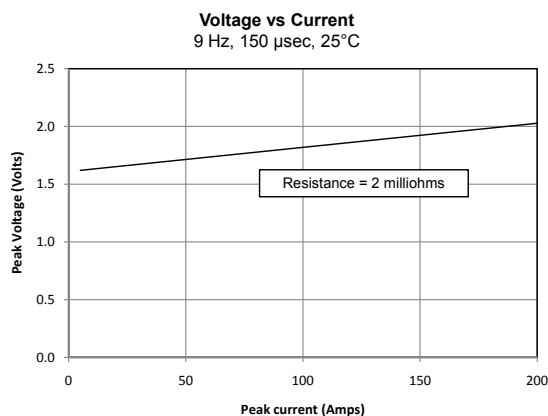
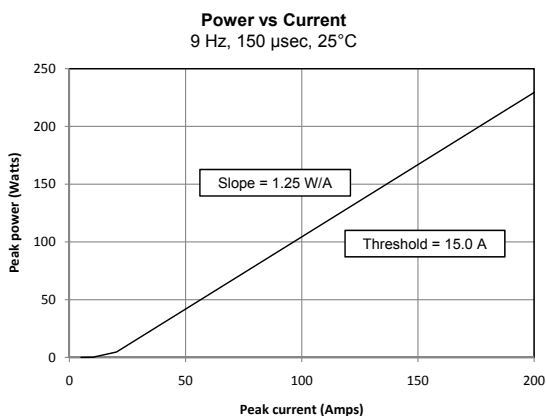

### MECHANICAL CHARACTERISTICS

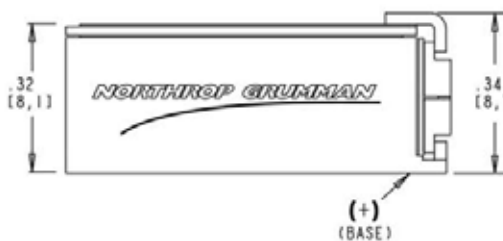
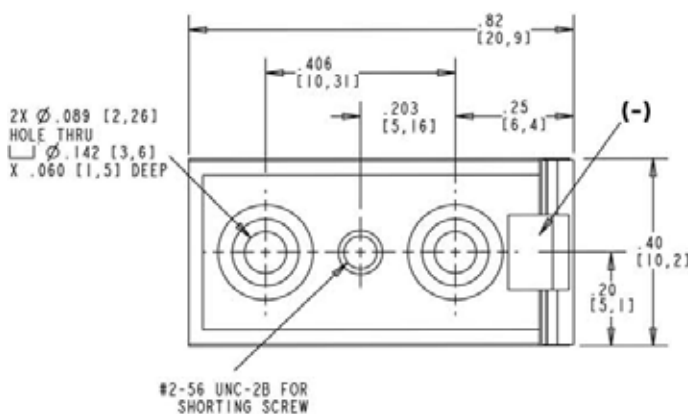

Copyright © 2008 Northrop Grumman Cutting Edge Optronics All Rights Reserved. Northrop Grumman Cutting Edge Optronics reserves the right to change product design and specifications at any time without notice. No license is granted by implication or otherwise under any patents or patent rights of Northrop Grumman Cutting Edge Optronics or others. No responsibility is assumed for the use of these products, nor for any infringement on the rights of others resulting from the use of these products. Information contained herein is believed to be reliable and accurate. Laser diode product components are intended for use in a user-devised end system. However, these products are capable of emitting Class IV radiation. Extreme care must be exercised during their operation. Only persons familiar with the appropriate safety precautions should operate a laser product. Directly viewing the laser beam or exposure to specular reflections must be avoided. Serious injury may result if any part of the body is exposed to the beam. The eye is extremely sensitive to the infrared radiation and therefore, proper eyewear must be worn at all times. Use of optical instruments with these products may increase eye hazard. Always wear proper eye protection when operating. This Product is covered by one or more of the following Patents: 5,898,211 | 5,985,684 | 5,913,108 | 6,310,900 | Other US and Foreign Patents Pending. Notes (1) These specifications apply for operation at 808nm. Other wavelengths available upon request. (2) A dry nitrogen environment should be provided by the user when storing and operating at temperatures below ambient dew point.

**DANGER**

INVISIBLE LASER RADIATION  
AVOID EYE OR SKIN EXPOSURE TO DIRECT OR SCATTERED RADIATION.

Diode laser  
5W & up, 780-1560nm  
CLASS IV

**WARNING**

ELECTROSTATIC DISCHARGE SENSITIVE DEVICE  
REQUIRING SPECIAL HANDLING

REV. A 10/09