

*This product is sold
and supported
in the USA by*

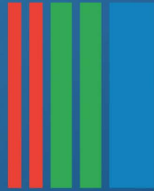

LASER LAB SOURCE
marketplace for **Scientists & Engineers**

contact@LaserLabSource.com

800.887.5065



CoBrite

Tunable Laser Instrument Series

User Manual

E-Mail: info@id-photonics.com
www.id-photonics.com

IDPHOTONICS GMBH 
ID Photonics GmbH, Neubiberg, Germany

V1.14
Status: 10/08/2020

Content

1	General Information	3
2	Unit Overview – Operating principle and block diagram	7
3	Quick Start – Remote Control	13
4	Getting Started	14
5	Description of front panel operation CoBriteDX.....	19
6	Description of instrument operation using the Web GUI.....	24
7	Remote Control	28
8	Copyright	41

1 General Information

1.1 Warning Laser Safety

The laser sources specified by this user guide are classified according to IEC 60825-1 (2007) Laser Notice No. 50 dated 2007-June-24 and comply with CFR 1040.10 except deviations per Laser Notice No. 50, July 2001 Key Feature Number 4.

This device is a Class 1M laser product for use only under the recommended operating conditions and ratings specified in this document. Use of controls or adjustments or performance of procedures other than these specified in this product datasheet may result in hazardous radiation exposure.

Do not view the laser output from this device directly with optical instruments (e.g., eye loupes, magnifiers, microscopes). Viewing the laser output with certain optical instruments within a distance of 100mm may pose an eye hazard. The class 1M laser product definition is based on all conditions defined in this section.

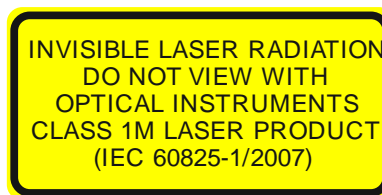

Please pay attention to the following laser safety warning: Under no circumstances look into the end of an optical cable attached to the optical output when the device is operational. The laser radiation can seriously damage your eyesight. Do not enable the laser when there is no fiber attached to the optical output connector. The laser is enabled by pressing the 'Laser on' button in the operating software delivered with the instrument. The laser is on when the red LED on the front panel of the instrument is lit. The use of optical instruments with this product will increase eye hazard.

In doubt about laser safety requirements consult a trained laser safety instructor for local safety requirements of this product.

1.2 Compliance Statement Electromagnetic Compatibility and device safety

Hereby, we confirm that the system has been demonstrated and audited for compliance for the following directives.

1.2.1 International

IEC 60950-1:2005, modified+Cor.:2006 + A1:2009, modified
CISPR 11:2003 in accordance with EN 61326-1: 2006

1.2.2 United States of America

FCC 47 CFR Part 15, Subpart B Class A, Measurement process ANSI C63.4 (2009)

1.2.3 European Union

EN 55022:2011
EN 61326-1: 2006
EN 61000-6-2: 2006
EN 61000-6-4: 2011
EN 61000-3-2: 2010
EN 61000-3-3: 2009

1.3 Limitation of communication interfaces

Operation of all USB Ports is limited to a maximum cable length of 3m and a maximum length of 30m for all Ethernet ports present.

1.4 European WEEE Directive Compliance

ID PHOTONICS has established processes in compliance with the Waste Electrical and Electronic Equipment (WEEE) Directive, 2002/96/EC. This product should not be disposed of as

unsorted municipal waste and should be collected separately and disposed of according to your national regulations. In the European Union, all equipment purchased from ID PHOTONICS can be returned for disposal at the end of its useful life. ID PHOTONICS will ensure that all waste equipment returned is reused, recycled, or disposed of in an environmentally friendly manner, and in compliance with all applicable national and international waste legislation. It is the responsibility of the equipment owner to return the equipment to ID PHOTONICS for appropriate disposal. If the equipment was imported by a reseller whose name or logo is marked on the equipment, then the owner should return the equipment directly to the reseller. If you have questions concerning disposal of your equipment, contact ID PHOTONICS's at WEEE@id-photonics.com.

1.5 Line Voltage Selection

CoBrite Mainframes operate from any single-phase AC power source that supplies 100 ~ 240VAC at a frequency at 50/60 Hz. The input line voltage setting is done automatically by *CoBrite* power supply.

1.6 Service

Do not attempt to service or adjust this instrument unless an authorized person is present. Do not install substitute parts or perform any unauthorized modifications to this instrument. Contact ID Photonics or your local distributor to obtain service support.

1.7 Help and User feedback

ID Photonics GmbH is dedicated to continuously improve customer experience of our products. Thus, if you have any feedback that might help us to improve our products send us an E-Mail to: feedback@id-photonics.com

1.8 Optical output of Laser Ports

Each laser port features a polarization maintaining Fiber output which can be both used with standard single mode fibers and polarization maintaining fibers. The emitted E-field is oriented along the slow axis of the fiber.

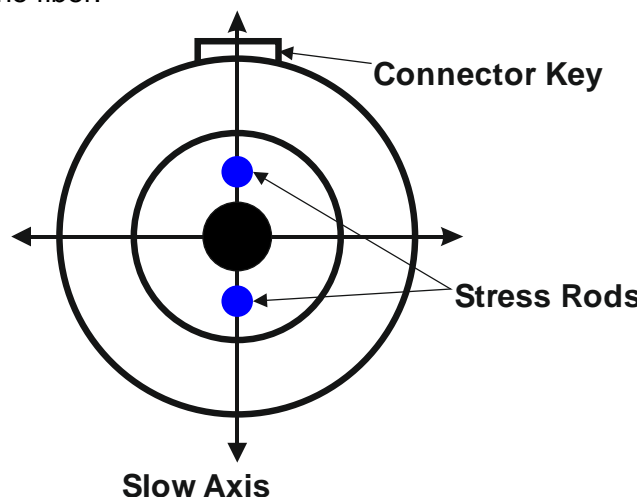

1.9 Safety

1.9.1 General Safety Precautions

The following general safety precautions must be observed during all phases of operation of this instrument. Failure to comply with these precautions or with specific warnings elsewhere in this manual violates safety standards of design, manufacture, and intended use of the instrument. **ID Photonics assumes no liability for the customer's failure to comply with these requirements.**

Before operation, review the instrument and manual for safety markings and instructions. You must follow these to ensure safe operation and to maintain the instrument in safe condition.

1.9.2 General

This product is a Safety Class 1 instrument (all units except CoBrite DX1, provided with a protective earth terminal). The protective features of this product may be impaired if it is used in a manner not specified in the operation instructions.

1.9.3 Environment Conditions

This instrument is intended for indoor use in an installation category II, pollution degree 2 environments. It is designed to operate at a maximum relative humidity of 95% and at altitudes of up to 2000 meters.

Refer to the specification tables for the ac mains voltage requirements and ambient operating temperature range.

Note: Before connecting electrical power to the unit, make sure the unit could acclimatize to ambient temperature for at least 2 hours to avoid damage by i.e. condensed humidity on electrical parts inside the unit.

1.9.4 Fuse Replacement

For continued protection against the possibility of fire, replace the fuse only with a fuse of the specified voltage, current and type ratings.

1.9.5 Before Applying Power

Verify that all safety precautions are taken. The power cable inlet of the instrument serves as a device to disconnect from the mains in case of hazard. The instrument must be positioned so that the operator can easily access the power cable inlet. When the instrument is rack mounted the rack must be provided with an easily accessible mains switch.

1.9.6 Maximum ratings

ALWAYS operate the unit within the maximum ratings. Ignoring these limits may result in permanent damage to the unit and loss of warranty.

1.9.7 Ground the Instrument

(this section does not apply to DX1 type chassis)

To minimize shock hazard, the instrument chassis and cover must be connected to an electrical protective earth ground. The instrument must be connected to the ac power mains through a grounded power cable, with the ground wire firmly connected to an electrical ground (safety ground) at the power outlet. Any interruption of the protective (grounding) conductor or disconnection of the protective earth terminal will cause a potential shock hazard that could result in personal injury.

1.9.8 Do Not Operate in an Explosive Atmosphere

Do not operate the instrument in the presence of flammable gases or fumes.

1.9.9 Do Not Remove the Instrument Cover

Operating personnel must not remove instrument covers. Component replacement and internal adjustments must be made only by qualified personnel.

Instruments that appear damaged or defective should be made inoperative and secured against unintended operation until they can be repaired by qualified service personnel.

Opening the instrument will result in loss of all warranty given for the instrument and may exhibit lethal health risks.

Keep away from live circuits inside the equipment. Operating personnel must not remove equipment covers. Only factory authorized service personnel or other qualified service personnel may remove equipment covers for internal subassembly or component replacement or any internal adjustment. Do not install substitute parts or perform any unauthorized modification of the equipment or the warranty may be voided.

1.9.10 Ventilation

Keep a space of 30 cm or more between the rear side of the device and any other objects such as walls to guarantee sufficient cooling of the device.

Never block the air fan and ventilation openings.

1.9.11 Cleaning the Instrument

To avoid personal injury, power down the device and disconnect it from line voltage before performing any of the following procedures.

To clean the exterior surface, perform the following steps:

Remove loose dust on the outside of the instrument with a lint-free cloth.

Use a soft cloth dampened with water to clean the device. Use 75% isopropyl alcohol solution as a cleaner. Do not use any abrasive or chemical cleaning agents.

1.9.12 Safety Symbols on Instruments

1.9.12.1 Warning or Caution



If you see this symbol on the product, you must refer to the manuals for specific Warning or Caution information to avoid personal injury or damage to the product.

1.9.12.2 ESD Safety Warning



This sign indicates that the respective modules, boards or RF inputs and outputs are susceptible to damage by electro static discharge (ESD), and require proper protection procedures for storage and handling.

1.9.12.3 Output of Laser Radiation Warning



This sign does indicate a source of optical radiation that may emit close to the location this label is present. Follow according laser safety procedures as listed below and defined in general rules at all times.

1.9.12.4 Wear Eye Protection

Wear eye protection if exposure to high-intensity rays or laser radiation exists according to Laser safety rules and best practices.

1.9.12.5 Do Not Directly View Optical Laser Port Output

Under no circumstances should you use any optical instruments to view the optical laser port output directly.

1.9.12.6 Precautions with Connectors

It is essential to ensure that all optical connectors are in good condition. Dirty connectors can lead to poor performance, while broken connectors can cause damage to other equipment! Before an optical connector is used, check it visually by using an optical microscope as recommended by the manufacturer of the connector. If the connector needs to be cleaned, apply the cleaning procedure recommended by the manufacturer of the connector. Make sure you are familiar with these issues to avoid damage to your device and possible violation of warranty.

Important!

Before connecting the inputs or outputs to any measurement equipment or device under test, make sure that a suitable attenuator, if necessary, is fitted.

2 Unit Overview – Operating principle and block diagram

2.1 CBDX

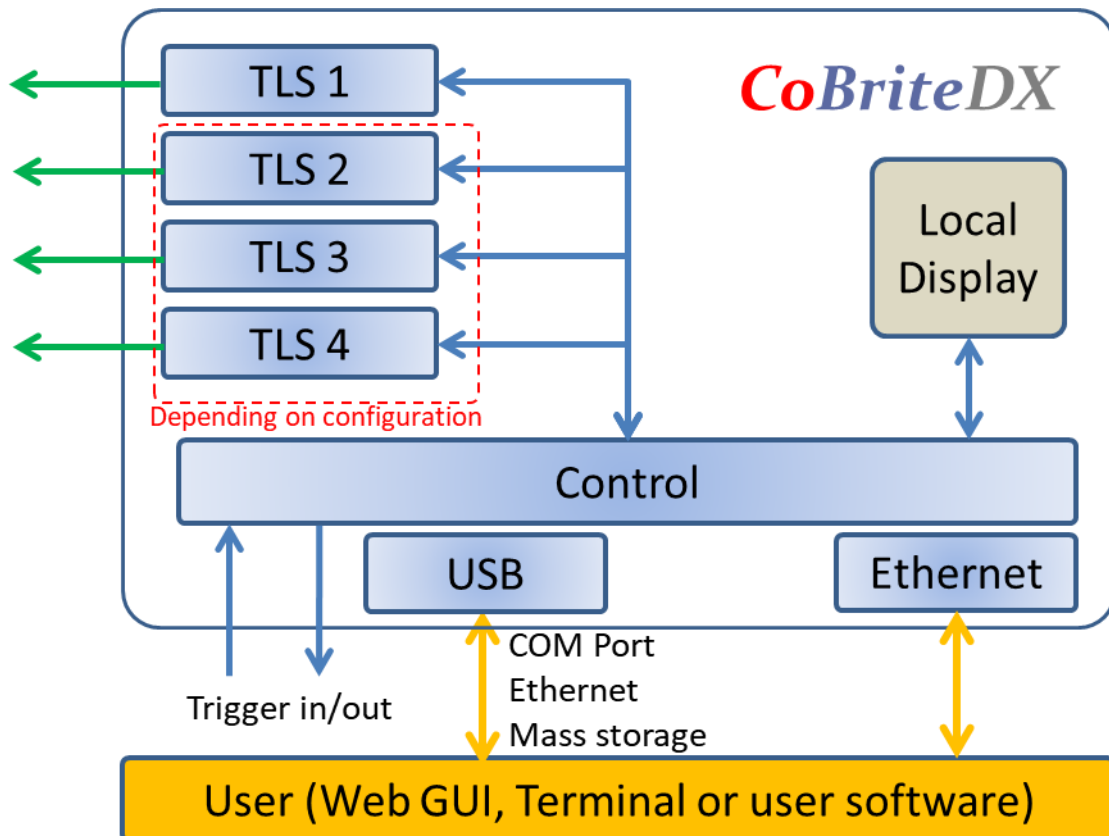

2.2 CBDX2

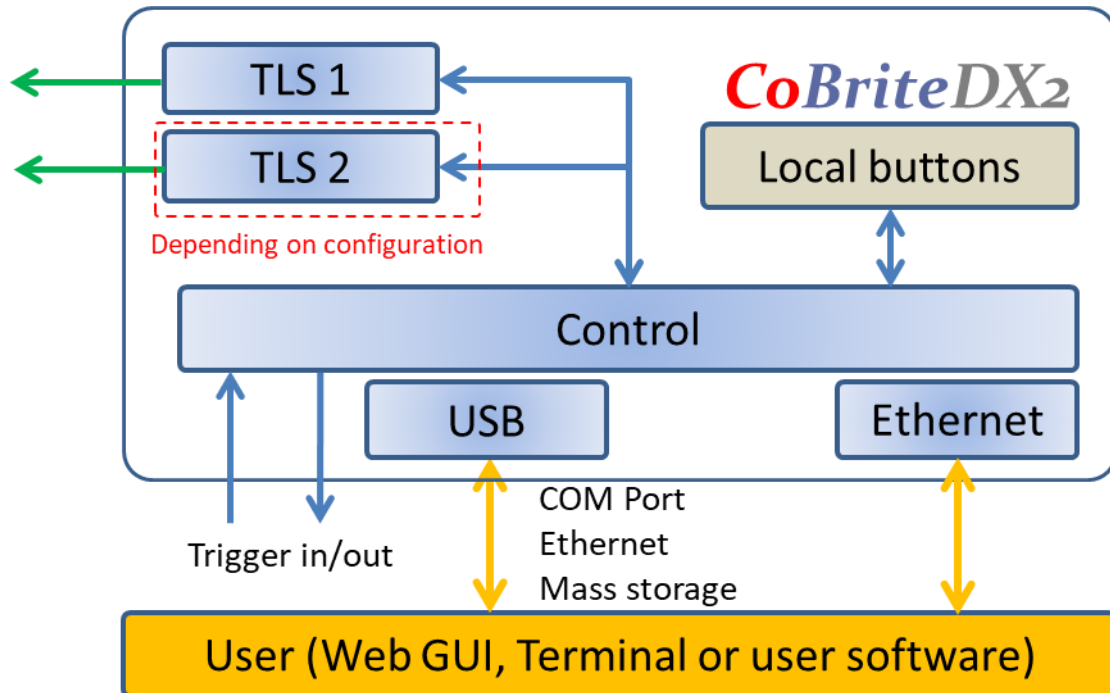

CoBrite is tunable laser instrument series capable of hosting up to 4 tunable laser ports that can be independently controlled. The series shares the same software and control architecture as well as the same portfolio of laser variants.

The CoBriteDX variant features a local touch panel display and supports up to 4 laser ports.

The more compact CoBriteDX2 supports up to 2 laser ports and is controlled remotely via the installation free browser-based GUI.

Different laser types are offered allowing users to adapt for various use cases such as coherent transmission, EDFA testing and insertion loss profile measurement.

User data transfer is provided via a SCPI interface utilizing USB and Ethernet interfaces. The unit supports multiple user connections and multiple user access right level administration. The user interface does not require any specific API Software or similar to be installed on host computers while providing a standardized communication protocol so that any user environment is able to communicate with unit.

The unit provides a built-in webserver that allows the control of the unit via any device such as PCs or smartphones that are able to run a Web Browser.

Using USB; the device provides a virtual Ethernet interface allowing to access the unit via browser or a telnet session. Additionally, a virtual COM port for straightforward serial access and a virtual Mass storage device (USB Stick) is installed providing access to the manual, programming examples and drivers.

The unit provides hardware triggers allowing triggering Laser setting executions as well as indication of laser tuning events.

2.3 CBDX – Front side of unit

The front side is dominated by a large Touch Panel Color Display for intuitive control of the instrument. The optical connector plate type depends on the laser configuration equipped on the specific unit. The 2 screws allow to easily detach the front plate to allow removal and cleaning of the connector.

Note The fibers attached to the plate are 250um buffered type and therefore sensitive to breakage under mechanical stress. So, take care if removing the connector plate to not damage optical fibers.

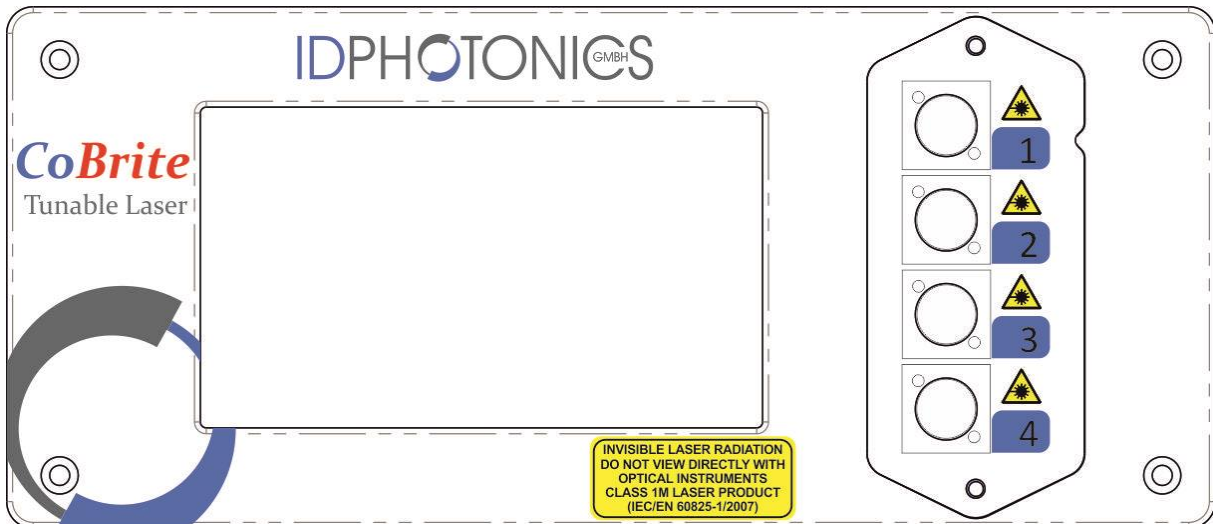

2.4 CBDX – Rear side of unit

The rear side hosts electrical connectors that can be utilized by the user.

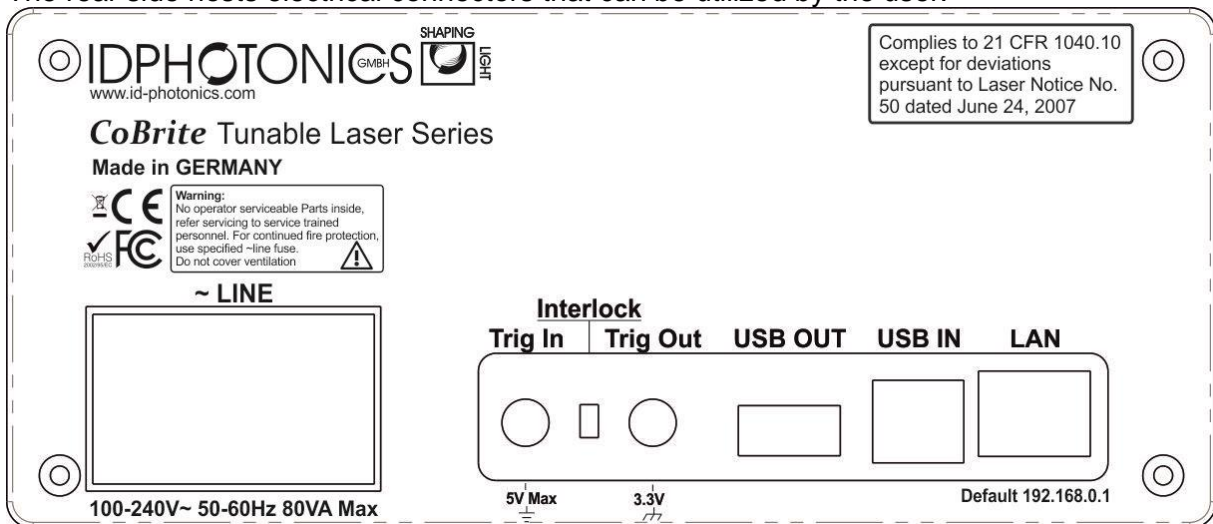

Note This unit contains a fan for forced air cooling. The inlet and outlet are slits located at the sides of the unit. Never block these areas to avoid overheating and failure of the unit.

2.4.1 Power socket

Electrical power is supplied using a VDE 0625, EN 60 320, C13 type electrical connector. Only use the supplied cable or an identical cable that conforms to the aforementioned standard to connect to the unit. The unit automatically adapts to local power line specifications within the range printed on the unit.

2.5 CBDX2 – Top side of unit

Note This unit utilizes the top cover for heat dissipation of internal components. Do not reduce the thermal dissipation by blocking the airflow in this area by placing items on it to avoid overheating of the unit.

2.6 CBDX2 – Front side of unit

The front side is dominated by a large Touch Panel Color Display for intuitive control of the instrument. The optical connector plate type depends on the laser configuration equipped on the specific unit. The 2 screws allow to easily detach the front plate to allow removal and cleaning of the connector.

Note The fibers attached to the plate are 250um buffered type and therefore sensitive to breakage under mechanical stress. So, take care if removing the connector plate to not damage optical fibers.

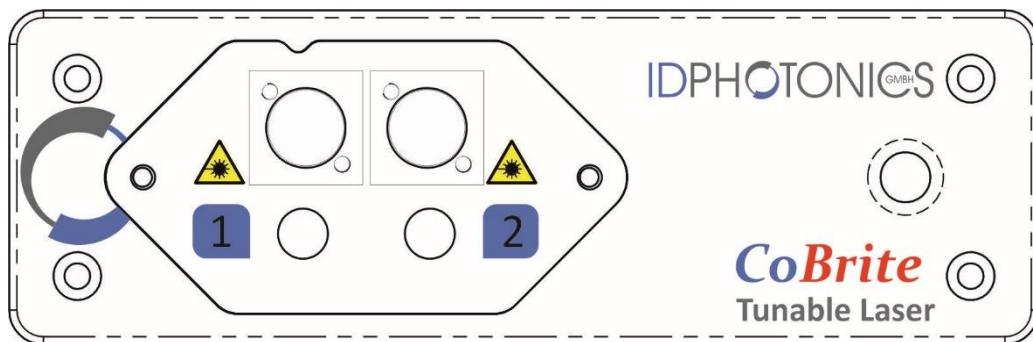

2.7 CBDX2 – Rear side of unit

The rear side hosts electrical connectors that can be utilized by the user.

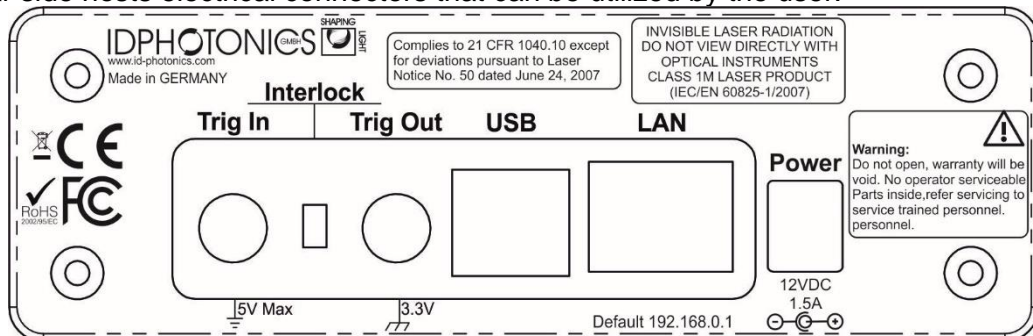

2.7.1 Power socket

Electrical power is supplied using a coaxial 12V DC jacket. Only use the supplied external AC/DC adaptor to power the unit. The AC/DC adapter unit automatically adapts to local power line specifications within the range and complies to standards printed on the adaptor.

2.8 CoBrite series - Common Ports

2.8.1 Trigger Ports

The SMA type sockets can be used to achieve timewise synchronization of the CoBrite with other equipment. Both ports support 3.3V LV TTL standardized signals.

Trigger IN allows triggering tunable laser setting if the feature is enabled via Remote control or GUI. Polarity and user set delays can be also configured this way. For positive polarity, the scan is started with the positive flank and will be fully executed regardless of the trigger in status afterwards. For negative polarity, the scan is triggered by the negative flank on the unit.

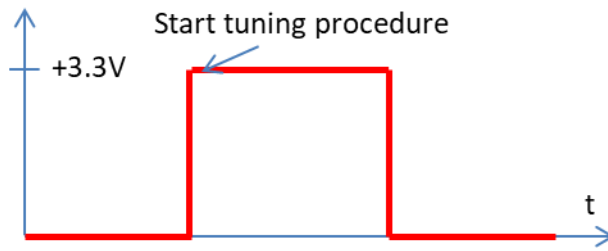

Each laser port installed on the chassis can be en- or disabled to be considered for the H/W trigger input using the command “TRINACT”. All considered ports are will only start to tune if a new setting has been set via software once the trigger in port has been initiated.

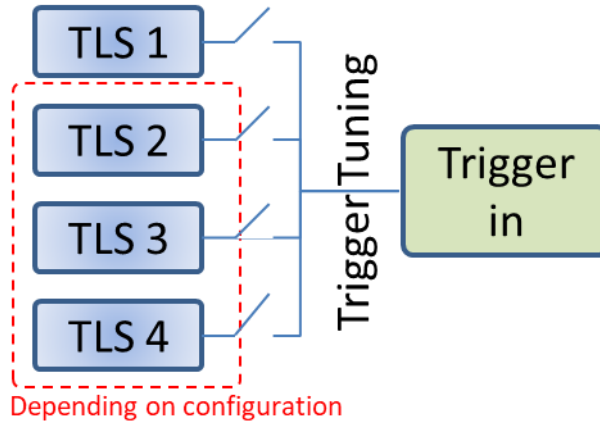

Note: Per default, “trigger tuning” for all Lasers are disabled. Use SCPI commands to alter configuration.

Trigger OUT provides an output signal indicating periods at which the one or more laser ports are tuning. The polarity of the signal and the logic of the signal can be changed via Remote control or GUI.

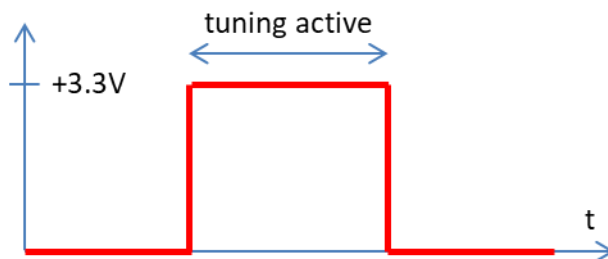

Each laser port installed on the chassis can be en- or disabled to be considered for the H/W trigger output using the command “TROUACT”. All considered ports are combined via a logical “OR” for the tuning active true state.

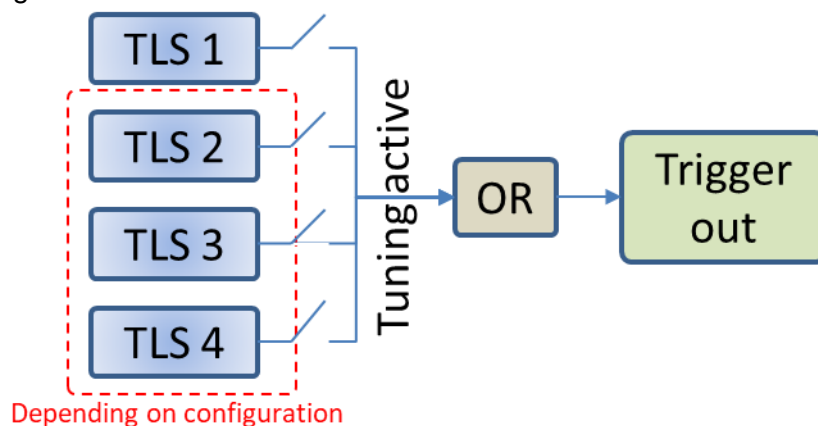

Note: Per default, “tuning active” signals of all Lasers are considered for the joint trigger out.

2.8.2 Interlock

Removing the interlock jumper disables the laser optical output. Note that the lasers will be disabled regardless of any software setting and cannot be overridden by software as this jumper directly acts on the laser hardware itself. The interlock status is indicated on the front panel(DX) as well as via remote software readout query.

2.8.3 Data Ports

Ethernet – The RJ45 jacket is used to connect the unit to Ethernet networks based on the IEEE 802.3 standard. Per factory default, the unit is set to a fixed IP Address 192.168.0.1. The IP address configuration can be changed via Remote control or GUI. We recommend to initially connecting via USB to set up the Ethernet interface first.

See section 4.2.3 for details on how to establish an application layer connection to remote control the unit.

USB IN – The USB 2.0 type B jacket is used to connect the unit a host computer to be able to operate the supplied GUI or perform remote control on the unit. See section 0 for details on how to establish an application layer connection to remote control the unit.

USB OUT – The USB 2.0 type A jacket is intended for future use and serves no functionality at this point.

2.9 Optional Accessories

2.9.1 Single 19" Rackmount Adaptor CBDX-19-1

This adaptor is used to mount one CoBriteDX chassis in a standardized 19" Rack in a 2 HE slot.

2.9.2 Single 19" Rackmount Adaptor CBDX2-19-1

This adaptor is used to mount one CoBriteDX2 chassis in a standardized 19" Rack in a 1 HE slot.

2.9.3 Single 19" Rackmount Adaptor CBDX-19-2

This adaptor is used to mount two CoBriteDX chassis in a standardized 19" Rack in a 2 HE slot.

2.9.4 Single 19" Rackmount Adaptor CBDX2-19-2

This adaptor is used to mount two CoBriteDX2 chassis in a standardized 19" Rack in a 1 HE slot.

For mounting instructions, see the separate guide which is supplied in case you have ordered these accessories or open the corresponding PDF on the USB stick or download it via the Web Interface of the instrument.

3 Quick Start – Remote Control

This section contains redundant information from other chapters but is useful for a first-time usage of the instrument.

1. Power up the unit using the main power switch located at the back of the unit
2. Wait until the boot sequence is completed. The local screen should look similar to this (DX)

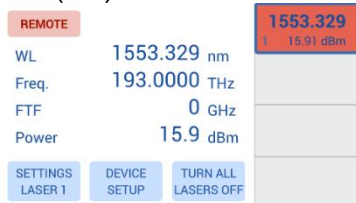

3. Connect the USB Port located at the rear of the unit to your Windows10 PC or connect the Ethernet Port to your LAN.
 - a. **For USB** based access, all drivers will be installed automatically, Windows device manager should show now 3 devices:
 1. A storage device containing manual etc.
 2. A virtual Ethernet Interface “RNDIS”
 3. A virtual COM PortBoth virtual COM and Ethernet Ports can be used to remote control the unit. The installed COM Port number can be retrieved from Windows device manager. The IP address by the command shell “ping cobrite.local”.
 - b. **For Ethernet** based access, the default IP of the unit is 192.168.0.1. Make sure that the host PC IP is in the same subnet as the laser unit (192.168.0.x). If this is not the case, you can change the IP settings of the unit via the touch screen or using the USB Port of the unit. Use “cobrite.local” as an alternative to the IP address to connect to the unit.
4. Open your Web browser, enter “cobrite.local” in the address field and hit <enter>. The Webpage allowing to control the laser remotely should open now.

Note: Depending on the configuration of your host PC DNS structure, the “cobrite.local” name representation might not be resolved into the correct IP address. In such a case, for a DX unit, retrieve the IP Address on the local touch panel under “Device Config – Network Config” and use it instead of the name. For a DX2 unit, open a connection to the USB virtual serial interface and type the command “USBIPADDR?;” to retrieve the USB IP Address or “IPADDR?;” for the IP address of the Ethernet interface.

4 Getting Started

This section contains more in-depth information on how to setup the remote interfaces on a host PC and basic principles of the laser.

4.1 Connection of Hardware

- Connect optical fibers to the laser output ports or make sure that no laser radiation can be uncontrollably emitted by the unit.
- Connect the power supply of the unit using the supplied Power Cord and switch on the unit using the switch located at the back of the unit.
- Wait for the unit to finish initializing. For DX4, the procedure is completed when the startup screen showing the ID Photonics logo is cleared and the laser parameters are shown. For DX1, the procedure is completed when the Power LED stops flashing. Now proceed with Software installation as described below.

4.2 Ethernet connection

This section covers connectivity using Ethernet, skip it if you plan on using USB.

The default IP address is 192.168.0.1, DHCP off. If you plan to connect using the Ethernet interface make sure the host PC is within the same subnet as the CoBrite Ethernet Interface (The PC IP Address is 192.168.0.x then). The connectivity can be tested by opening a command shell (type “cmd” in windows search field and hit <enter>, a “black window with a DOS shell should open) and executing the command “ping 192.168.0.1”.

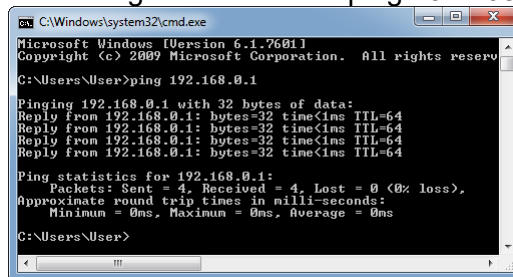

```
C:\Windows\system32\cmd.exe
Microsoft Windows [Version 6.1.7601]
Copyright (c) 2009 Microsoft Corporation. All rights reserved.

C:\Users\User>ping 192.168.0.1

Pinging 192.168.0.1 with 32 bytes of data:
Reply from 192.168.0.1: bytes=32 time<1ms TTL=64
Reply from 192.168.0.1: bytes=32 time<1ms TTL=64
Reply from 192.168.0.1: bytes=32 time<1ms TTL=64
Reply from 192.168.0.1: bytes=32 time<1ms TTL=64

Ping statistics for 192.168.0.1:
    Packets: Sent = 4, Received = 4, Lost = 0 (0% loss),
    Approximate round trip times in milli-seconds:
        Minimum = 0ms, Maximum = 0ms, Average = 0ms

C:\Users\User>
```

If you do wish to change the IP settings and do not have remote access to the unit follow either of the following sections depending on the type of chassis:

4.2.1 CoBriteDX

Use the local touch panel and press “Device Setup”. Then press “Network setup” and configure the interface accordingly. Note that this change will require a reboot (soft reset of the unit) to become effective.

4.2.2 CoBriteDX2

If you do wish to change the IP settings of the unit, we recommend first connecting via USB and changing the IP settings via USB connection.

Note that changing the IP address requires the user to be connected with user level 1 or higher. Send the command “pass IDP” or enter the password “IDP” in the GUI to elevate the user level to 1. This change will require a reboot (soft reset of the unit) to become effective.

4.2.3 Opening a remote connection via Ethernet

The device supports a session based remote access on Port #2000.

Start the terminal program “putty.exe” supplied with the unit or use any other terminal program. Set the following parameters in Putty and open the connection:

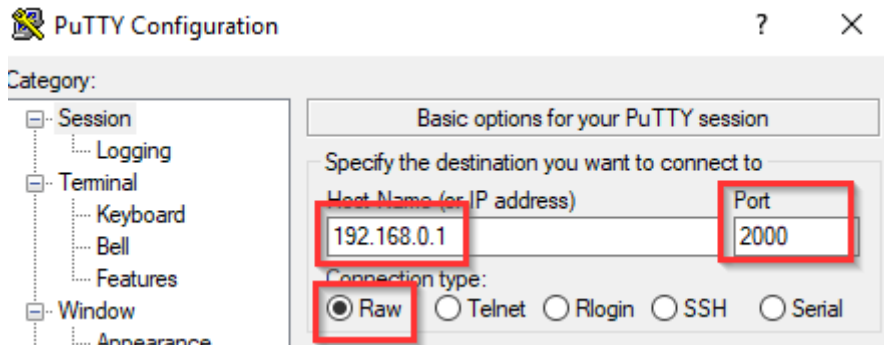

Alternatively to the default IP Address shown above, enter “cobrite.local” or the IP address currently set to the unit. If in doubt, use the touch panel display “Device config” – “IP config” to retrieve the actual IP Address.

Note that there must be a valid route on the IP layer between the device and the host PC (i.e. the ethernet port of the host PC is set to the same subnet as the device, for example 192.168.0.2) must be established before continuing. Use a command shell and command “ping cobrite.local” to test the route.

Once the connection is established, type in “*idn?” and hit <ENTER>. The unit responds with its *idn? String.

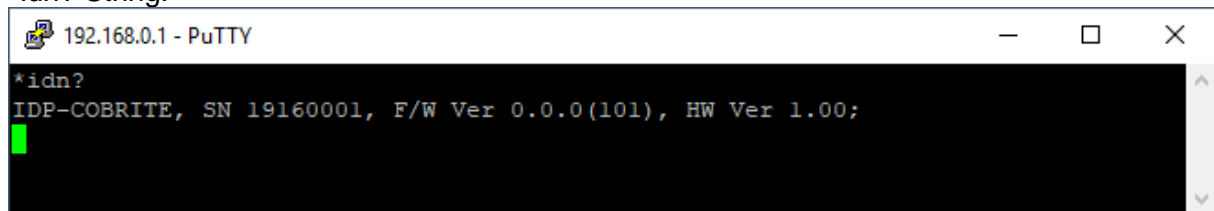

Alternatively, a request based remote control via http Port 80 is possible. To test this, open a browser window and type the following string into the address field:

http://cobrite.local/scpi/*idn?

For more details, see section 7.2.

4.3 USB Connection

This section covers connectivity using USB, skip it if you plan using Ethernet.

Once the unit is powered up and the USB cable is connected to the host computer for the first time, a new device installation should be triggered automatically within Windows.

Once installation is complete, three devices are installed on the host computer:

1. Virtual Ethernet Interface
2. Virtual COM Port
3. Virtual Storage device that contains resources such as manual and programming devices as well as drivers for Windows 7.

4.3.1.1 Windows 10

Windows 10 will automatically install 3 devices allowing to connect the unit

1. A virtual Ethernet interface (RNDIS)
2. A generic virtual COM port driver “Serial USB device”. If you have several COM ports installed in the host PC, you may want to note the COM Port number under which the unit got installed. For further details on USB connection, see section 4.3.1.3.
3. A storage device similar to an USB Stick containing resources for the laser unit

The virtual COM Port and the virtual Ethernet interface are concurrent ways to access the unit for remote control. The web-based control is automatically accessed via entering “cobrite.local” into your browser.

4.3.1.2 Windows 7

Windows 7 will install the same structure as described in the windows 10 section above. It will automatically install a virtual Ethernet interface (RNDIS) and the USB storage device (“Linux File- Store Gadget USB Device”). However, it does not have a preconfigured driver setup for the virtual COM Port. It will try to locate a driver for the unit on the host PC first and then check

online. Stop the search and select the option “Install a custom driver”. Point the installation routine to the driver located on the USB storage device provided by the unit in directory “USBDriverWin7” and select file “CoBriteUSBSerialDriverWindows7.inf” in this folder. If the installation has been completed already, open Windows Device Manager, locate “CDC Serial”, right click on it and select “Update driver”. Proceed as described before.

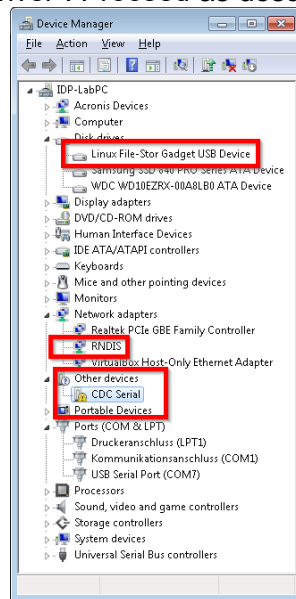

Continue with the installation routine. Once installed, the virtual COM port should appear in Windows Device Manager as shown below. The COM Port number will be different for your system. Note down the number for later usage in remote control applications.

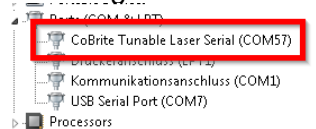

4.3.1.3 Connection to the device via USB via Host PC

Once installed properly, the USB connection provides a virtual COM Port and a virtual Ethernet Port to the instrument. To access the unit via virtual Ethernet, follow the instructions as in section 4.2.3 but note that the IP Address of the unit will be different as for the physical Ethernet Port.

To access to the unit using the virtual COM port, open a terminal window using the installed COM port number per description above.

4.4 Installation of Control Software

This instrument does not require any installation of software for operation. Once connected to a host PC or a local network, simply enter “cobrite.local” into the address field of your Web browser to access the unit.

4.5 What if “Cobrite.local” cannot be reached by host computer?

Depending on the configuration of your host PC DNS structure, the “cobrite.local” might not be resolved into the correct IP address. In such a case, for a DX unit, retrieve the IP Address in local Touch display under “Device Config – Network Config” and use it instead of the name or use the following method described for DX2 units.

Note that there are 2 IP addresses shown, one for the physical Ethernet interface (Network Interface) and one for the virtual Ethernet interface installed via USB. For a DX2 unit, open a connection to the virtual serial interface and type the command “USBIPADDR?;” to retrieve the IP Address for USB connection and “IPADDR?;” for physical Ethernet.

After retrieving the address, enter the corresponding IP address into your browser address field to access the unit.

4.6 Laser modes

Coarse tuning allows accessing the full specified tuning range while fine tuning (FTF) allows for offsetting from the coarse tuning set point by a small range. The resulting set point is the sum of coarse tuning set point and FTF/fine tuning value.

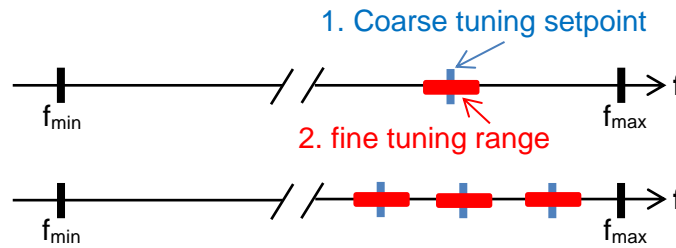

4.6.1 Coarse tuning

This tuning mode allows tuning the laser to any frequency of the available range specified for the laser port. The tuning process will require the output to be disabled for a short period of time.

Description of tuning process:

1. Output will be switched off (~1 second)
2. Output is switched on using new frequency
3. Power is increased until final output power is reached. Maximum tuning times for this step differ from laser type to laser type.
4. Power is stabilized, tuning process is completed.

Note that the time to tune the laser is the actual time required to tune the laser, the software based tuning indicator may indicate a tuning state for a longer time period than the actual tuning requires.

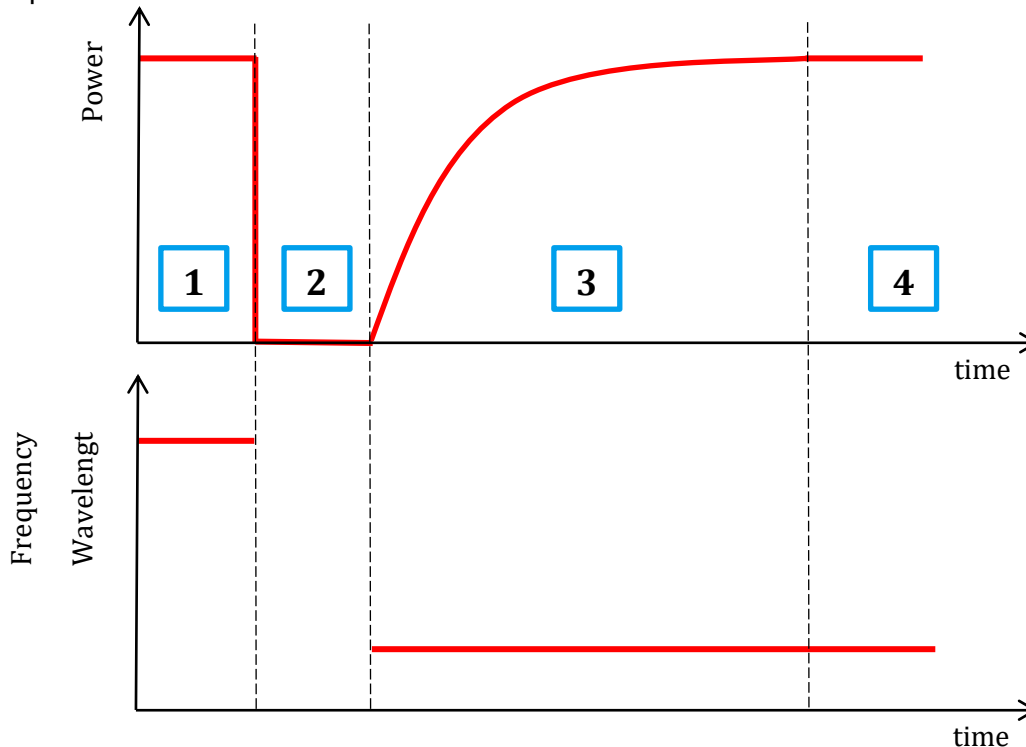

4.6.2 Fine tuning (FTF)

Fine tuning allows detuning the laser within a small range from the target frequency set using the coarse tuning parameter. The laser will detune to the target setting with output power on during the tuning process which changes the output frequency in a linear ramp.

1. -Tuning is triggered

2. Tuning process taking ~1second per GHz. Power remains constant – Power remains constant
3. Laser settles on new value

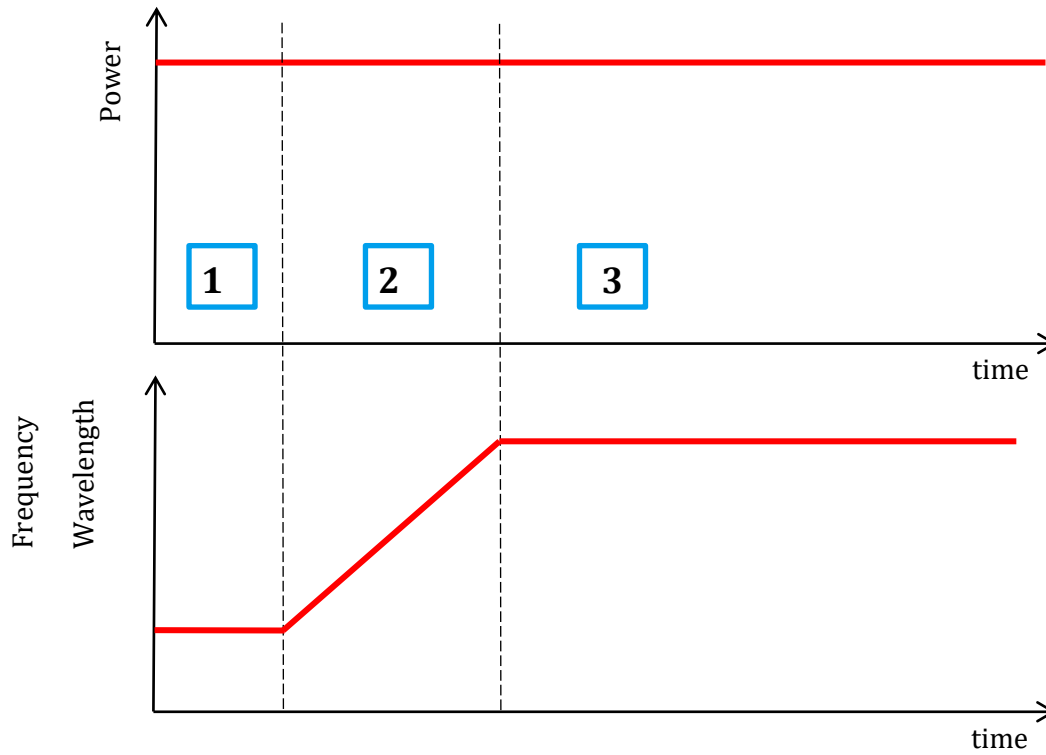

5 Description of front panel operation CoBriteDX

After the device has initialized, the front panel will look as depicted below:

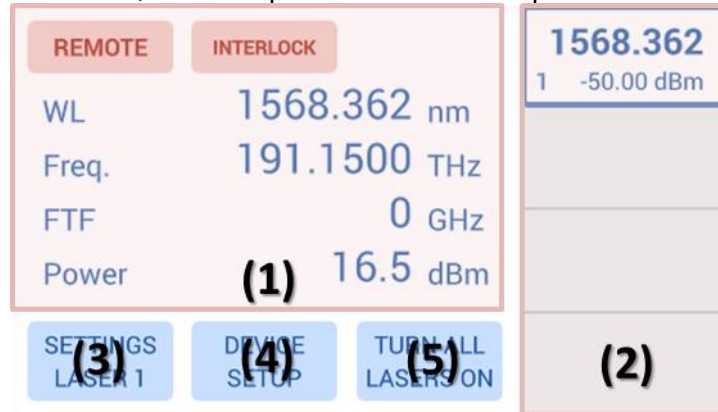

- (1) The central main field displays key parameters defining the current optical status of a laser selected by the right-hand tab. Touch on any of the parameters to change them.
- (2) The right-hand side tabs display the laser ports installed in the unit indicating on/off/tuning status by the background color, current wavelength/frequency and optical output Power. Touch a tab briefly to select the laser to display details in the central main field. If the tab is pressed for a longer time, an increasing red progress bar will be displayed. If at 100%, the laser will be toggled on if previously off or vice versa. A flashing background indicates that the laser is currently tuning.
- (3) Pressing “Settings Laser x” will open a pop up allowing to change parameters of the selected laser.
- (4) “Device Setup” allows changes to the chassis set up such as IP configuration, base unit wavelength/frequency etc. See below for details.
- (5) “Switch on/off all lasers” will simultaneously en- or disable the laser output power.

The red “Remote” indicator will only be displayed if one or more remote connections are active. “Interlock” will only be displayed if the hardware laser safety jumper located at the rear of the unit has been removed. In this state, all lasers are disabled and can only be switched on again if the jumper is installed again.

“Error” will only be displayed in case of active errors present.

The screenshot below is taken in a regular operational state with 4 Laser outputs switched on. Laser 1 is selected

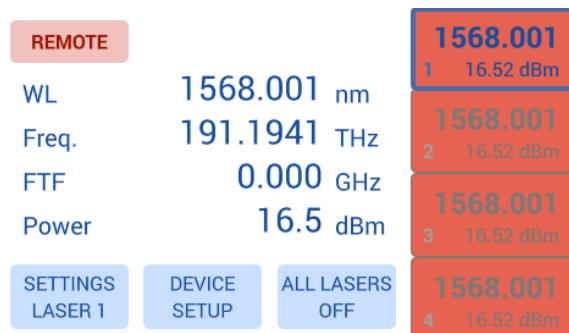

To enable or disable the laser output, touch the laser selection button for about 1 second. If the laser status is off, the field will start to fill red. Once the field is filled, the laser will be switched on and vice versa for switching the laser off. The same method applies to the “All Lasers On/Off” button.

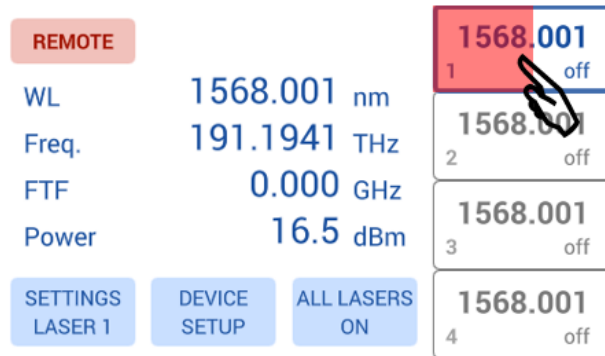

A flashing laser selection button indicates that the laser is currently tuning.

5.1 Settings Laser

Touching “Settings laser x” button or the central current status field will open a popup allowing to set the laser parameters.

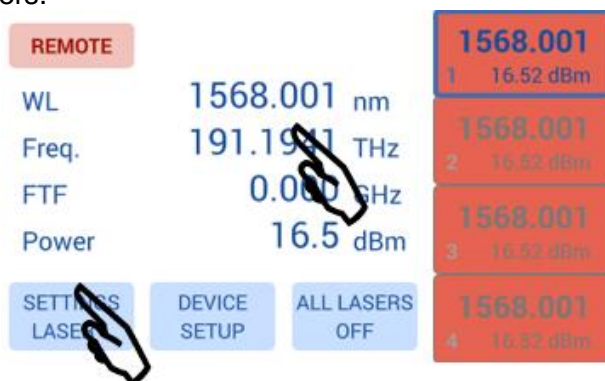

Select the parameter to be changed by touching on the corresponding button. The current parameter setting is displayed in the field below. Change the setting by swiping the corresponding roll bar to change each digit or use the horizontal slider for coarse tuning. If a value exceeding the limits of the laser is dialed in, the limits will be shown and the ok button will be disabled. Move the setting back to a valid setting or cancel the popup. Once the new setting is dialed in, proceed to the next parameter or press “ok” or switch to the next laser port to be set by pressing the Laser “x” button located on the upper left side. The laser will be subsequently tuned to the new setting. The tuning process is indicated by a flashing of the port overview located at the right-hand side. The base unit for the laser Wavelength/Frequency can be changed in the “Device Setup” popup.



In Frequency mode, a touch button “Grid” is displayed that allows applying a virtual Grid to the Frequency roll bar. With this, the minimum increment of the laser frequency equals the grid value set. Note that this feature will not alter the settings of the laser port itself but eases the

setting touch panel of the laser. A concurrent remote session will still be able to set the laser to any frequency it supports.

5.2 Device Setup

Touching “Device Setup” button located in the main screen will open a popup allowing to set device parameters.

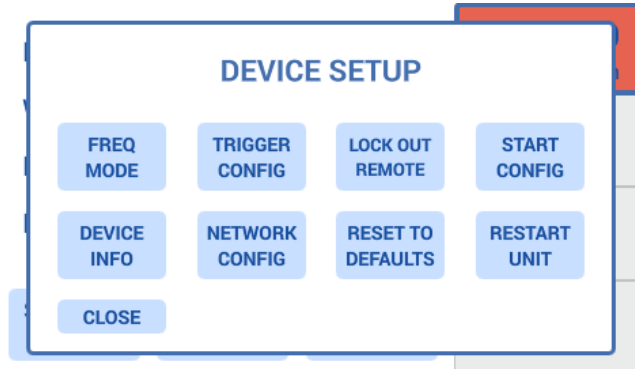

5.2.1 “Wavel. Mode” / “Freq Mode”

toggles the base unit for setting the laser between wavelength and Frequency in the Laser setting Popup as well as the Laser selection button located right hand side on the main screen.

5.2.2 “Trigger Config”

Defines the trigger action configuration. Press the corresponding buttons to toggle the setting. See section 2.8 details on trigger configuration.

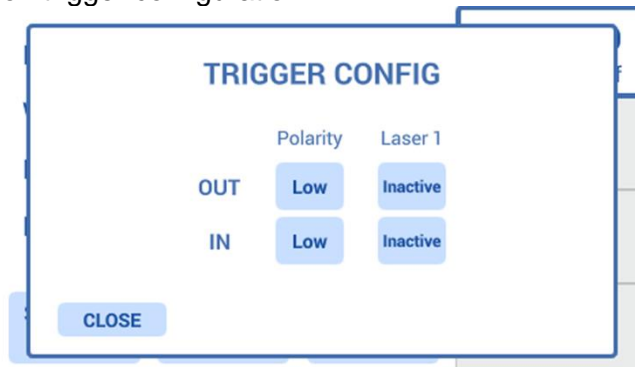

5.2.3 “Lock out Remote”

will block remote commands that alter the configuration of the unit to prevent interfering commands coming in by these remote connections. A popup up to confirm the change of the setting will be shown as potentially active remote connections will no longer be able to issue commands. A remote connection is any access established to the unit via USB or Ethernet and applies both to the Web-GUI and any user program.

5.2.4 “Start Config”

Allows configuring the Startup behavior of the unit. “Start configuration” allows two settings:

“Factory defaults” starts the laser ports with predefined settings defined by ID Photonics.

“Last Configuration” will save the settings each time it is changed by the user and set these upon restart of the unit.

“Laser Autostart” will allow to also set the last laser output on/off setting upon restart of the unit.

CAUTION: If enabled, the lasers may automatically switch on upon restart of the unit.

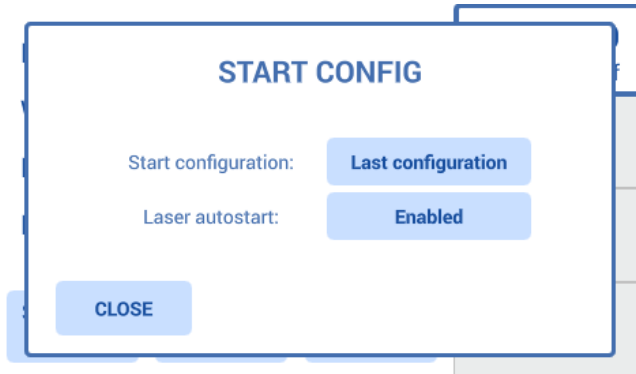

5.2.5 "Device Info"

Provides Information such as Software revision, serial number and device configuration.



5.2.6 "Network Config"

Displays the Network Configuration of the physical Ethernet Interface as well as the virtual Ethernet Interface available on the USB Port allows setting the parameters by clicking on the corresponding parameter button.

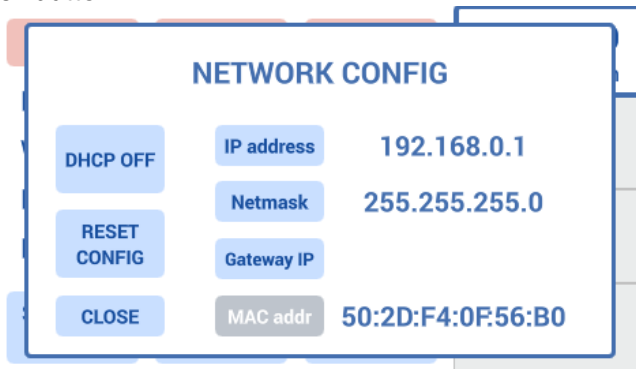

Popup to set the IP address:

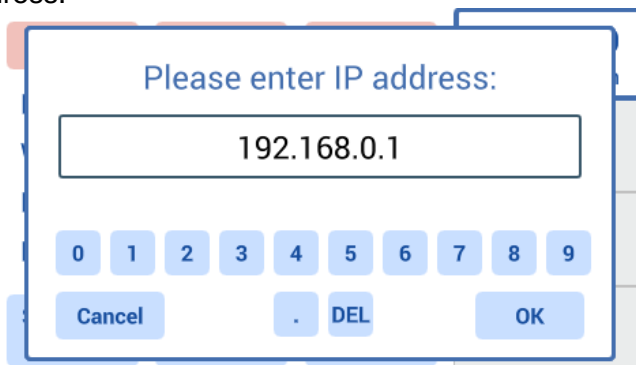

Note that changes to the Network settings will only take effect upon restart of the unit. Therefore, after a change of settings, a popup will appear allowing to restart the unit.

5.2.7 “Reset to Defaults”

This will reset all settings stored by the user back to the factory defaults except any remote interface setting. A popup containing a warning will be displayed and needs to be confirmed before the settings are deleted.

5.2.8 “Restart Unit”

Will perform a reboot of the unit. This action is identical to the SCPI remote control command “*rst”.

5.3 Description of front panel operation CoBriteDX2

The more compact DX2 chassis allows to en- or disable the output of the corresponding laser port by pressing the red button located next to each port. Note that this requires the unit to have started up which takes about 20seconds after power on and the interlock jumper located at the rear of the instrument to be disabled (jumper set, default).

This button simultaneously acts as a port status indicator:

- LED off indicates that the laser output is currently off
- LED on indicates that the laser output is currently on
- A flashing LED indicates that this laser port is currently tuning to a new setting

Use the remote-control panel to access any other setting of the laser.

6 Description of instrument operation using the Web GUI

The laser chassis can be accessed by any device such as smartphones, PCs etc. that are able to operate a web browser.

If connected via USB, a virtual Ethernet interface is installed on the host system so that the Web Interface based access is enabled.

To access the unit, enter “cobrite.local” or the current IP address of the unit into the address field of the browser to open the GUI.

The “All Lasers off/on” button allows toggling laser on/off status of all laser ports at the same time.

The Files Dropdown menu allows opening resources such as the manual related to the unit. These resources are stored locally in the unit.

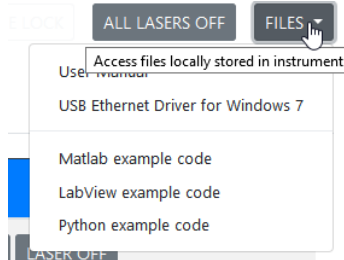

6.1 “Lasers” Tab

The start page launches in Tab “Lasers” and contains a table of which each line is representing a laser port with the port coordinate scheme defined in the remote section of this manual.

A pulsing graphic indicates that the connection is still active and information is continuously updated. If the animation stops, the connection to the device is lost and must be re-established to communicate with the instrument.

Port	Type	Wavelength [nm]	Frequency [THz]	FTF [GHz]	Set Power [dBm]	Actual Power [dBm]	State	Actions
1-1-1	EC	1568.756	191.1020	0.0	10.0	off	OFF	SETTINGS LASER ON
1-1-2	SC	1568.609	191.1200	0.00	17.8	off	OFF	SETTINGS LASER ON

Each line indicates the current setting of each laser port and the laser type present.

Change one Parameter – To change the setting, click on the corresponding parameter and enter a new value which will be set to the laser port after the “ok” button was clicked.

Change several Parameters at once – Click on the “Settings” button. A Popup opens in which parameters can be changed. Complete the change by clicking “save changes” or discard by clicking “close”. The advantage of this method is that all parameters are changed in one tuning cycle as opposed to several subsequent cycles if the parameters are entered one after the other as described before.

6.2 „Trigger“ Tab

Defines the trigger action configuration. Press the corresponding buttons to toggle the setting. See section 2.8 details on trigger configuration.

Lasers Trigger System Connection

Trigger configuration

	Polarity	Laser 1	Laser 2	Laser 3	Laser 4
Trigger Out	Low	Inactive	n/a	n/a	n/a
Trigger In	Low	Inactive	n/a	n/a	n/a

6.3 “System” Tab

This tab gives an overview of the device configuration and status.

Some buttons and fields may be disabled. To access these features, elevate the user level of the current session by entering the corresponding password in tab “connection”. For details, see the remote section 7.4.

“Alarm details” provides more details in case of a failure. Alarms can be latched so that intermittent occurrences can be detected by the user. These alarms can be acknowledged and cleared by pressing “Clear latched alarms”

“Reset to defaults” will reset all settings stored by the user back to the factory defaults except any remote interface setting. A popup containing a warning will be displayed and needs to be confirmed before the settings are deleted.

The “SCPI Control” field allows executing commands defined in the remote section of this manual. The response will be displayed in a popup window. The user level for execution is the same as for the whole browser session. “Abort pending command” allows to stop pending commands in the command queue.

“Identify unit” will open a blinking button in the local touch display or, in case of a DX2 unit, flash the laser port LEDs of the connected unit. It allows the identification of the unit currently controlled by this session in case several units are present on the network.

“Restart unit” will restart the connected unit after a popup confirms the reboot action.

Allows configuring the Startup behavior of the unit. “Start configuration” allows two settings:

“Factory defaults” starts the laser ports with predefined settings defined by ID Photonics.

“Last Configuration” will save the settings each time it is changed by the user and set these upon restart of the unit.

“Laser Autostart” will allow to also set the last laser output on/off setting upon restart of the unit.

CAUTION: If enabled, the lasers may automatically switch on upon restart of the unit.

6.3.1 Firmware update

“Firmware Update” allows installing a new firmware into the unit. Please follow the following steps:

1. Connect via the Web Interface
2. Elevate the user level to at least 1 by entering the password in tab “connection”. The default password is “IDP”. Note that this may have been changed by a user before.
3. Use the “search File button” to locate the firmware file provided by ID Photonics. Then press “Update Firmware”. Do NOT close the browser window yet.
4. The file is first uploaded to the device, checked and installed. Once the process is complete, a popup will inform the user that the installation is complete.
5. Press “Restart unit” to perform a warm start of the unit to activate the new firmware.
6. After restart, make sure to reload the web browser window to empty the cache. The current installed firmware version can be checked in “Connection” Tab under “Device info” or in the local touch panel interface (DX chassis only).

The screenshot shows the 'Connection' tab of a web interface. At the top, there are navigation tabs: 'Lasers', 'Trigger', 'System', and 'Connection'. The main content area is divided into several sections:

- Alarm details:** Lists 'Laser temperature too high', 'Interlock active', 'Controller communication failure', and 'Laser error'. A 'Clear latched alarms' button is below.
- Configuration:** A 'Reset to defaults' button.
- SCPI control:** A 'Send command:' label, a text input field containing '*idn?', and an 'Abort pending commands' button.
- Device management:** 'Identify unit' and 'Restart unit' buttons.
- Start configuration:** 'Start with last configuration' and 'Laser autostart enabled' buttons.
- Firmware update:** 'Select update package:' label, a search input field with 'Durchsuchen...' and 'Keine Da...ewählt.' options, and an 'Update firmware' button.

6.4 “Connection” Tab

This Tab provides info on the device such as Part/Serial Number, Hardware and installed Firmware revision.

It also allows to change the IP Configuration of the network interfaces of the device.

“User level authentication” allows entering a password to elevate the session user level rights which will enable buttons and fields currently disabled. For details, see remote section 7.4.

“Connection status” indicates active communication between the unit and the browser session. The blue dot will morph its size when communication is active.

The screenshot displays the 'Connection' tab interface, divided into two main sections: 'Network settings' and 'Device info / Connection status / User level authentication'.

Network settings:

- DHCP:** A red bar indicates 'DHCP is disabled'.
- IP address:** Input field containing '192.168.0.1'.
- Netmask:** Input field containing '255.255.255.0'.
- Gateway IP:** Empty input field.
- DNS1 IP:** Empty input field.
- DNS2 IP:** Empty input field.
- MAC-Address:** Input field containing '50:2D:F4:0F:56:B0'.
- Reset network settings to defaults:** A blue button at the bottom of the network settings section.

Device info:

- Idn: COBRITE CBDX-SC-NN-NN-NN-FA, SN 19330099, F/W Ver 1.0.0(362), HW Ver 1.00

Connection status:

- A blue dot indicates active communication.

User level authentication:

- Password:** An empty input field.
- Login:** A blue button next to the password field.

7 Remote Control

This device operates using SCPI standard style commands which are ASCII based and allow easy communication and interpretation with the instrument. Refer to chapter “Board and Connector description” on how to establish communication to the ports available at the instrument. More detailed information on SCPI syntax can be found here:

<http://www.ivifoundation.org/docs/SCPI-99.PDF>

7.1 Operating multiple Interface Ports

This unit supports parallel usage of all remote-control ports available. Note that responses to commands issued are only returned to the according interface from where the command was issued.

Commands are generally executed in order of time wise arrival to the controller and buffered into an Event queue. If a stack overflow occurs, an error is issued.

Note that there is no control exclusivity for a specific interface or user. Thus, parallel commands issued by different instances will be might lead to inconsistencies. It is therefore recommended to poll current parameter status to ensure integrity of set vs. actual parameters and query the operation complete register (“*opc?”) to make sure all previous commands have been executed or applied to the laser control. Note that it is recommend to use the query “busy?” to determine if a laser port is still tuning as the “*opc?” query will only tell if the corresponding change of configuration has been triggered but might not be completed.

7.2 Query Connection types

Connections to remote control the unit via SCPI can be made either by using telnet protocol on port 2000 or HTTP queries. While for performance reasons, telnet-based access should be preferred, HTTP based access can be used in installations where Port 2000 is blocked by Network firewalls or routers since HTTP uses Port 80 which is open in most networks.

7.2.1 Telnet based

Connections made with the device can be session based by a raw terminal connection (see 4.2.3) using Port 2000 for Ethernet or a COM Port session (4.3.1.3).

Connections through HTTP Service (Port 80). In this case, the SCPI command is encapsulated in the following http request:

```
http://<CoBrite Ip>/scpi/<SCPI-Command>
```

7.2.2 HTTP based

Example: http://cobrite.local/scpi/*idn? queries the identification string of the unit.

For a quick test, simply copy this query into the browser address field.

The ASCII encoded response is identical to the session-based response.

<wsp> characters defined in the SCPI definitions are to be replaced with ASCII string “%20” per HTML code standard requirements. No termination character “;” or <CR> is needed for HTTP based access.

Multiple commands can be sent within a single query by means of separation via the termination character “;”

Example: http://cobrite.local/scpi/*idn?;lay?

Note that this connection type is not session based like the terminal connection. So, each query sent will establish a new session which is terminated after response the query response is given. Consequently, commands requiring elevated user rights will require to send the password with the actual query in the same request.

Example: <http://cobrite.local/scpi/pass%20IDP;pass?>

will send the password “IDP” to the unit to elevate

7.3 Syntax conventions for commands

7.3.1 Long and short form

The key words feature a long form and a short form. Either the short form or the long form can be entered in one command, other abbreviations are not permissible.

Example: “:SYStem:IPADDRess?” is equal to “IPADDR?”

Note: The short form is marked by upper-case letters; the long form corresponds to the full expression. Upper-case and lower-case notation only serve the above purpose, the instrument itself accept both upper-case and lowercase letters.

Note: All commands are case insensitive. Long and short form may not be mixed within a single command.

7.3.2 Query commands

Most commands serve a double function that allows either setting or executing a query on a parameter.

Note: Query commands are terminated by a “?” character.

7.3.3 Parameter

Parameters must be separated from the header by a “white space”. If several parameters are specified in a command they are separated by a comma “,”.

7.3.4 Colon Character

A leading colon character “:” instructs the instrument to interpret the command starting at the root (highest level) of the command tree. Since the Instrument also starts at the root each time you send it a new command, the leading colon is not required (although the instrument will accept it if you send it).

7.3.5 Command Termination character

Each command must be terminated either by a “;” character or a carriage return (ASCII #13) to signal completion of the command telegram to the controller.

Note: Sending two termination characters is a common mistake causing the unit to respond with “ERR 100;” since the first command is executed once the first termination character is received and the second termination character causes the unit to interpret an empty command. Example:

Command: “wav 1550;<CR>”

Response “;<CR>ERR 100, unknown command;”

The unit will set wavelength 1550nm to port 1,1,1 but additionally receives the empty command which causes the error response.

7.3.6 Acknowledgement of executed commands

The mainframe controller will always acknowledge successful execution of commands by a “;” character. If the echo option is set (for details, see command list), the accordingly sent command is returned first.

7.3.7 Laser port addressing scheme

Laser ports are addressed by a three-level port identifier that allows easy identification of the port and are issued as parameters with according commands. Each level parameter is separated by a “,” character.

Note: If no laser port address is added to the command, Laser port 1,1,1 is addressed automatically, i.e. `SOUR:WAV?` Queries the wavelength setting of laser port 1.

Identifier	Description
<C>	Chassis identifier 1: Always 1 for CBDX chassis type
<S>	Slot identifier. Range: 1 : Always 1 for CBDX chassis
<D>	Device identifier for Laser port on each card. Range: 1 : Always 1 for CBDX1 chassis type 1 – 4: CBDX chassis type

Example: `SOUR:WAV? 1,4,2;` queries the current wavelength of Port 1 on card 4 in chassis 2.

7.3.7.1 Wild card character

A special wild card character "*" is used to address several ports at a time. This can be used for both set commands and query commands

Example: `SOUR:WAV 1,2,* 1555.1234;` will set all Lasers of slot 2 in chassis 1 to 1555.1234nm.

Note: If a query is executed using a wildcard character, the parameter will be preceded a location identifier. Parameters returned for each port are separated by a „\n“ (=ASCII Code #10) for easier readability.

Example: `SOUR:WAV? 1,2,*;`

Will query current wavelength of all lasers of slot 2 in chassis 1 and will return:

```
1,2,1,nnnn.nnnn\n
1,2,2,nnnn.nnnn\n
1,2,3,nnnn.nnnn\n
1,2,4,nnnn.nnnn;\n
```

7.3.8 Communication example

Host sends: `*idn?;`

unit response: `IDP-COBRITE CBDX-NC-NN-NN-NN-FA, SN 19160001, F/W Ver 1.0.0(101), HW Ver 1.00;`

7.3.9 Basic script example

The following commands can be a minimal script to perform a basic set up of the unit and read the data

Command	Comment
<code>INTI;</code>	Initialize Communication settings
<code>*IDN?;</code>	Query idn string of unit
<code>PASS IDP</code>	Raise user level to 1
<code>DEFAULT;</code>	Sets unit settings to factory default
<code>WAV 1550;</code>	Sets Laser 1-1-1 Wavelength to 1550nm
<code>pow 14;</code>	Sets output Power of laser 1-1-1 to 14 dBm
<code>stat 1;</code>	Enables Laser 1-1-1 output
<code>*opc?;</code>	Queries if command has been executed (status 1).
<code>busy?;</code>	Queries if the laser port has finished tuning and has settled on target settings that were set before

Screenshot of script example result:

```

192.168.0.1 - PuTTY
INTI
;
*IDN?
COBRITE CBDX-SC-NN-NN-NN-FA, SN 19330099, F/W Ver: 0.0.0(156), HW Ver 1.00;
PASS IDP
;
DEFAULT
;
WAV 1550
;
pow 14
;
stat 1
;
*opc?
1;
busy?
0;

```

<ENTER> was used to execute the command. Alternatively, use “;”.
 <ENTER> was used to execute the command. Alternatively, use “;”. If both is used, it is interpreted as 2 commands of which the second one is empty so that the first command is executed but the second produces an error since empty.

```

192.168.0.1 - PuTTY
*OPC?
1;
*OPC?;
1;
ERR 100, unknown command;

```

7.4 User access level

This feature allows execution of commands protected in standard access level to avoid accidental change of important parameters. See command description “[:SYStem:]PASSwOrd” for details on how to enable enhanced access.

Custom passwords can be set to the unit for enhanced security requirements. See details in description for “[:SYStem:]SetPASS<wsp>, <P>, <P>”.

Note: User access level is granted session based. Each time, a new remote connection is made; the standard User access level 0 is set per default.

User access level	Password
0	-
1	IDP

7.5 Notation of Syntax for command definition

Syntax and Type	Description
[]	Optional command level that can be omitted. Example: Definition [:SYStem:]IPADDRess/? /<P> Allows sending the command: IDADDR?
< >	Denotes a parameter. Placeholder is replaced with parameter value defined for according command. Definition [:SYStem:]IPADDRess/? /<P> Allows setting the parameters: [:SYStem:]IPADDRess 192.168.0.1
/?	Denotes the optional character “?” that is used if the command can also be used as a query. Example: Definition [:SYStem:]IPADDRess/? /<P> “?” is used to query current IP Address of the device: IPADDR?;

:	Usage of Colon see 7.3.4
<wsp>	Denominates a white space character
<INT>	Integer value
<REAL>	Real value

7.6 General SCPI Commands

Syntax	Example	Description
*idn?	*idn?; COBRITE CBDX-NC- NN-NN-NN-FA, SN 19160001, F/W Ver 1.0.0(101), HW Ver 1.00;	Query System Type and Software version. The CoBrite DX is identified by CBDX. The CoBriteDX2 by CBDX2. The remaining string is determined by the laser configuration of the actual device. It matches the part number that is printed on the label on the unit.
*opc?	*opc?; 1;"	Query if all pending commands were executed. Note that this will NOT indicate if physical tuning of laser ports has been completed. Use busy? Query for this.
*rst	*rst;	Reset Controller; will warm start the instrument. All connections/sessions will be closed. Requires user level 1
*WAIt	*WAI; ;	Unit waits with response until *opc? is 1. Eliminates need for polling loop of *opc? on remote side
*CLS	*CLS; ;	Clears all status/alarm registers of the unit. This command is used to clear latched alarm registers.

7.7 Commands on system level

Syntax	Read Write	User access level	Parameter format	Description
[:SYStem:] ECHO / ? / <wsp> <P>	RW	0	"0" or "1"	Sets or query echo command sent status, this setting applies to current session only
[:SYStem:] DEFAULT	W		-	Resets user settings such as laser settings to factory default. This affects all settings including trigger configuration except Remote interface settings.
[:SYStem:] STArtDEFault / ? <wsp> / <P>	RW	1	"0" or "1"	Queries/Sets of unit starts with last settings set before a reboot or with default of device. This affects all settings except Remote interface settings and Laser Port on/off status. 0 = Save each change of setting and restart with current config upon next reboot 1 = Always start with unit factory defaults

Syntax	Read Write	User access level	Parameter format	Description
[:SYStem:] ENABLeAUTO STArt/?<wsp>/<P>	RW	1	"0" or "1"	Enables or disables if laser port on/off status is saved and executed upon reboot.
[:SYStem:] INfOrmatIOn?	R	0	IDP-COBRITE, SN 19160001, F/W Ver 1.0.0(101), HW Ver 1.00;	see *idn? For detailed description
[:SYStem:] DHCP/?/<wsp><P>	RW	1	"off" or "on"	configure DHCP Setting for Ethernet interface
[:SYStem:] IPADDRess/?/<wsp><P>	RW	1	xxx.xxx.xxx .xxx	IP Address Setting of Ethernet interface
[:SYStem:] NETMASK/?/<wsp><P>	RW	1	xxx.xxx.xxx .xxx	Netmask Setting of Ethernet interface
[:SYStem:] GATEWAYIP/?/<wsp><P>	RW	1	xxx.xxx.xxx .xxx	IP address for Gateway of Ethernet interface
[:SYStem:] DNSIP/?/<wsp><P>	RW	1	xxx.xxx.xxx .xxx	IP address for 1 st DNS of Ethernet interface
[:SYStem:] DNSIP2/?/<wsp><P>	RW	1	xxx.xxx.xxx .xxx	IP address for 2 nd DNS of Ethernet interface
[:SYStem:] USBIPADDRess?	R	0	xxx.xxx.xxx .xxx	IP Address Setting of virtual Ethernet interface on USB
[:SYStem:] USBNETMASK?	R	0	xxx.xxx.xxx .xxx	Netmask Setting of virtual Ethernet interface on USB
[:SYStem:] MACADDRESS?	R	0	XX:XX:XX:XX:XX:XX	Reads MAC Address of unit
[:SYStem:] IPConfigDEFault	W	1	-	Resets all settings of remote interfaces to factory defaults. This becomes effective only after a reboot of the unit.
[:SYStem:] INTerfaceINIT	W	0	-	Reset session parameters to defaults. Call this after opening the remote port. This commands resets ECHO, PASS, FORMAT, UNIT:X, LINLOG, EVENT.
[:SYStem:] REMote?	R	0	"0" or "1"	Query remote status of device. Any open remote sessions via Ethernet?
[:SYStem:] PASSword/?/<wsp><P>	RW	0	ASCII	Set new User level status by sending password or query current User level status
[:SYStem:] TIME?/<wsp><P>	R(W)	0	xxxxxxxx	Query or set system time. Note that time is set and tracked in volatile memory only. It requires to be set after each cold start.

Syntax	Read Write	User access level	Parameter format	Description
[:SYStem:]ALARm?	R	0	xxxxx	Query alarm status of device, see Alarm code definition for details
[:SYStem:]STATUs?	R	0	"INIT","FAULT","READY","OVERLOAD"	Query current state of OSA; see Alarm state for match
[:SYStem:]ERRor [:NEXt]?	R		-	Queries data in an error queue and deletes it from the queue.
[:SYStem:]COMMunicate:]LOCKout/?	RW	1	"0" or "1"	Locks other sessions to perform write commands on the unit. It is automatically released if the active session closes
[:SYStem:]COMMunicate:]ParameterREFresh?	R	0	<INT>	This query allows detecting if any change to the 34eparately configuration was done. Each time the counter increases, the configuration was changed. This is useful in multi-user environments to detect if a parallel session has changed settings on the unit
[:SYStem:]IPConfCHanged?	R	0	0 1	Check if IP configuration of the Ethernet Interface was changed but no reboot was triggered yet to activate the new settings. This can be used to determine if the actual settings differ from the settings that will be active upon restart.
[:STATUs:]OPERation:]EVENT?	R	0	-	Read status of instrument if scan has been completed (1) or not (0). Each read of "EVENT?" will clear the status for each remote session 34eparately. This can be used to query if previous scan has been completed.
[:]ABORT	W	0	-	Aborts all currently executed pending commands as fast as possible. Query *OPC? To determine status once all pending commands are aborted
[:BOOT:]BootLoaDerRESet	W	0	-	Resets upload procedure for firmware upgrade. All data uploaded already is erased. New process can be restarted
[:BOOT:]BootLoaDerAPPend	W	0	binary	send portions of the binary Firmware Image, each Byte is coded into 2 Characters 1..F, send max. 100 Bytes per command

Syntax	Read Write	User access level	Parameter format	Description
[:BOOT:] BootLoaDerEX ECute/?	RW	0	-	Set: Executes upgrade of previously uploaded Firmware image. Query responds with current status of execution.
[:SYStem:] ENableLOGg ing/?	RW	R 0 W 1	"0" or "1"	This command enables local logging in the unit that can be used for debugging purposes. Enable this only if a persistent issue exists and ID Photonics asked you to enable the feature since this can slow down the performance of the instrument. The trace file read via RDEBUG is encrypted and cannot be checked by the user.
[:SYStem:] ReadDEBUG	R	0	-	Collects debug information from OSA which can be sent to ID Photonics for troubleshooting. Returns a maximum of 1000bytes per read. Responds "WAIT" as long as debug data is still collected. Responds "EOL" if all data is read.
[:SYStem:] IDENTify<w sp><P>	W	0	"0" or "1"	En- or disables blinking of the on the unit allowing identification of the unit attached to remote control.
[:SYStem:] LAYout?	R	0	-	Query chassis configuration. The response returns the chassis type (CBDX1, CBDX, CBMX) and lists the installed slots and corresponding number of lasers. Example: lay? Response: CBDX, 1, 1, TLS1;
[:SYStem:] INTLock?	R	0	"0" or "1"	Query the status of the interlock setting. Optical output of lasers can only be enabled if the interlock jumper is set.
[:SYStem:] CARD: INFOR mation? <C>, <S>, <D>	R	0	<INT>	Query card level information. For DX chassis, the response is identical to *idn? Query
:SYStem:RESet	W	1	-	Will reset instrument. Same as command *rst, see details in description of *rst
[:SYStem:] SetPASS<w sp>, <P>, <P>	W	-	-	Sets a password to access the defined user level. Requires current user level to be at or higher for level that password is to be set. First parameter is user level for which password is set, second is a string defining the password.

7.7.1 Trigger commands

All trigger commands require user access level 1 and read and writable.

PORT coordinate per common definition: <C>,<S>,<D>

Syntax	Parameter format	Description
[:SYStem:]TRIGGERDElay/?<wsp>/<P>	<INT>	'Queries/Sets trigger delay for scan trigger IN. Setting the delay will cause the laser tuning process to be delayed relative to the trigger event by the parameter given in Milliseconds. The 0 Setting will cause the scan to be started without delay.
[:SYStem:]TRIGGERPOLarity/?<wsp>/<P>	{IN, OUT}, 0 = ACTIVE LOW; 1 = ACTIVE HIGH	Queries/Sets trigger signal polarity of input/output. Trigger IN: 1 (Active high, default) means that a high-level signal triggers a new scan if enabled, 0 will cause a low signal to trigger a new measurement. Trigger OUT: 1 (Active high, default) means that a high-level signal is generated if a scan is complete and available to read, it will return low once the next scan is started. The Signal is low if no scan was performed yet. The 0 setting will cause the output to be low if a scan is completed and high again once a new scan is triggered. The signal is high if no scan was performed yet. Example: TRIPOL IN,1;
[:SOURce:]TRIGGEROUTACTive/?<wsp><C>,<S>,<D> /<P>	{0, 1}	Queries/Sets trigger output signal to be used for laser port. 0: Laser Port tuning state will not change Trigger Output state. 1: Laser Port tuning state will be used for logical Trigger Output state. Example: TROUTACT 1,1,1,1;
[:SOURce:]TRIGGERCONFiguration/?<wsp><C>,<S>,<D> /<P>	See details of command [:SOURce:]CONFiguration	Set or Query current configuration of Laser in location C-S-D in csv format that is executed if a trigger signal is detected at the Hardware Trigger Input port. This command will be buffered until either the trigger is executed. The parameters for this command are identical to the command [:SOURce:]CONFiguration. If a new Laser Port setting using a command such as conf, wav, frequ, onof is sent, the buffer filled by triconf is cleared. An empty response to "the triconf?" query indicates that the buffer is empty.

7.8 Laser Port Commands

Command	Parameter Type
[:SOURce:]WAVelength/?<wsp><C>,<S>,<D> /<P>	<REAL>nm
Sets or queries the wavelength setting of a tunable laser port. Value format is in Nanometer. Example: WAV 1550.012; sets Laser Port 1,1,1 to 1550.012nm	
[:SOURce:]WAVelength:LIMit/?<wsp><C>,<S>,<D>	<REAL>nm
Queries the wavelength setting limits of a tunable laser port. Value format is in Nanometer. Example: WAV:LIM?; queries Laser Port 1,1,1 Response with min and maximum limit: 1528,1565;	

Command	Parameter Type
[:SOURce:] FREQuency/?<wsp><C>, <S>, <D>, /<P>	<REAL>THz
Sets or queries the wavelength setting of a tunable laser port. Value format is in Tera Hertz. Example: <code>FREQ 192.15</code> ; sets Laser Port 1,1,1 to 192.15THz.	
[:SOURce:] FREQuency:LIMit?<wsp><C>, <S>, <D>	<REAL>THz
Queries the frequency setting limits of a tunable laser port. Value format is in Tera Hertz. Example: <code>FREQ:LIM?</code> ; queries Laser Port 1,1,1. 2 value Response with min and maximum limit: 191.1020,196.1020;	
[:SOURce:] OFFset/?<wsp><C>, <S>, <D>, /<P>	<REAL>GHz
Sets or queries the frequency offset setting of a tunable laser port. Value format is in Giga Hertz. Example: <code>OFF 11.15</code> ; sets Laser Port 1,1,1 offset to 11.15THz. Value can be positive or negative.	
[:SOURce:] OFFset:LIMit?<wsp><C>, <S>, <D>	<REAL>GHz
Queries the offset setting limits of a tunable laser port. Value format is in Giga Hertz. Example: <code>OFF:LIM?</code> ; queries Laser Port 1,1,1 Response 12; It is a single value since the offset is symmetrical to 0.	
[:SOURce:] POWer/?<wsp><C>, <S>, <D>, /<P>	<REAL>dBm
Sets or queries the optical output power target setting of a tunable laser port. Value format is in dBm. Example: <code>POW 11.15</code> ; sets Laser Port 1,1,1 power of 11.15dBm	
[:SOURce:] ActualPOWer?<wsp><C>, <S>, <D>	<REAL>dBm
Queries the current optical output power reading of a tunable laser port. Value format is in dBm. Example: <code>APOW?</code> ; 11.15; queries the Laser Port 1,1,1 answer is 11.15dBm	
[:SOURce:] DITheR/?<wsp> <C>, <S>, <D>, /<P>	1,0,-1
Sets or queries the dither state of a laser port. If the feature is not available, “-1” is returned for queries or an error for set commands. Example: <code>DITH 1</code> ; enables Laser Port 1,1,1 dither.	
[:SOURce:] LIMit?<wsp><C>, <S>, <D>	<REAL>
Query maximum tuning Parameters of Laser in location C-S-D in csv format. <Minimum Frequency>,<Maximum Frequency>,<Fine tuning Range>,<Minimum Power>,<Maximum Power> Example: <code>LIM?</code> ; queries Laser Port 1,1,1	
[:SOURce:] CONFIguration/?<wsp><C>, <S>, <D>, /<P>	<REAL>
Set or Query current configuration of Laser in location C-S-D in csv format: <Frequency>,<Offset>,<Output Power>,<Output state>,<Busy state>,< Dither state>, Busy state : <INT> “1”,“0”, Only for query, if set is used, this parameter is omitted Dither state: <INT> “1”,“0”,“-1” If queried and “-1” is reported, laser does not support this feature. If set and laser does not support the feature, the parameter setting must be “-1”. Example read: <code>SOUR:CONF? 1,2,3</code> ; returns 191.42,10.134,6.12,0,1,-1; The laser is set to 191.42THz, 10.134GHz FTF, 6.12dBm, output on (1) , not busy tuning (0), dither not supported(-1) Example write: <code>SOUR:CONF 1,1,1,193,1,7,1,-1</code> ; will set the to 193THz, Fine tuning 1GHz, 7dBm output power, 1: laser on, 1: dither not supported. Note: For SC Type lasers, Frequency and offset cannot be changed within a single command. Use 2 commands to set them separately.	
[:SOURce:] BUSY? <wsp><C>, <S>, <D>	<INT>
Query if laser port is currently tuned “1” or settled “0”.	

Command	Parameter Type
[:SOURce:] STATE/?<wsp><C>, <S>, <D>, /<P>	<INT>
Query if laser is on "1" or off "0"	
[:SOURce:] MONitor?<wsp><C>, <S>, <D>	<REAL>
Query monitor readings from laser. Response: <LD chip Temperature>, format nn.nn, unit °C <LD base Temperature>, format nnnn.n, unit mA <LD chip current>, format nnnn.n, unit mA <TEC current>, format nnnn.n, unit mA Example: MON? 1,2,3; Returns 29.23, 25.12, 125.1, 1043.2	

7.8.1 Command Property overview

7.8.1.1 System Level Commands

Session based parameters/commands will be initialized to default each time a new connection/session is opened to the instrument.

Syntax	Read Write	User access level	Session based	Default value	Stored if STADEF =0
[:SYStem:] ECHO/?/<wsp><P>	RW	0	X	0	-
[:SYStem:] STArtDEfAult /?<wsp>/<P>	RW	1	-	1	-
[:SYStem:] DEfAULT	W		-	-	-
[:SYStem:] INfOrMation?	R	0	-	-	-
[:SYStem:] DHCP/?/<wsp><P>	RW	1	-	OFF	-
[:SYStem:] IPADdRess/?/<wsp><P>	RW	1	-	192.168.0 .1	-
[:SYStem:] NETMAsK/?/<wsp><P>	RW	1	-	255.255.2 55.0	-
[:SYStem:] GATEWAYIP/?/<wsp><P>	RW	1	-	192.168.0 .255	-
[:SYStem:] DNSIP/?/<wsp><P>	RW	1	-	192.168.0 .255	-
[:SYStem:] DNSIP2/?/<wsp><P>	RW	1	-	192.168.0 .255	-
[:SYStem:] MACADdRESS?	R	0	-	-	-
[:SYStem:] IPConfiGDEfAult	W	1	-	-	-
[:SYStem:] INtERfAcEInit	W	0	-	-	-
[:SYStem:] REMOte?	R	0	-	-	-
[:SYStem:] PAsSWord/?/<wsp><P>	RW	0	X	-	-
[:SYStem:] TIME? /<wsp><P>	R/(W)	0	-	-	-
[:SYStem:] ALARm?	R	0	-	-	-
[:SYStem:] STATUs?	R	0	-	-	-
[:SYStem:] ERROr [:NEXT] ?	R		-	-	-

Syntax	Read Write	User access level	Session based	Default value	Stored if STADEF =0
[:SYSTem:COMMunicate:]LOCKout/?	RW	1	-	0	-
[:SYSTem:COMMunicate:]ParameterREFresh?	R	0	-	0	-
[:STATus:OPERation:]EVENT?	R	0	-	-	-
[:]ABORT	W	0	-	-	-
[:BOOT:]BootLoaDerRESet	W	0	-	-	-
[:BOOT:]BootLoaDerAPPend	W	0	-	-	-
[:BOOT:]BootLoaDerEXECute/?	RW	0	-	-	-
[:SYSTem:]ENableLOGging/?	RW	1	-	0	-
[:SYSTem:]ReadDEBUG	R	0	-	-	-
[:SYSTem:]IDENTify<wsp><P>	W	0	-	0	-
[:SYSTem:]ENABLEAUTOSTArt/?<wsp>/<P>	RW	1	-	0	-
[:SYSTem:]STArtDEFault/?<wsp>/<P>	RW	1	-	1	-
[:SYSTem:]SetPASS<wsp>,<P>,<P>	W	-	-	1	-

7.8.1.2 Laser Port Commands

Command	Read Write	User access level	Stored if STADEF =0
[:SOURce:]WAVelength/?<wsp><C>,<S>,<D>,<P>	RW	0	✓
[:SOURce:]WAVelength:LIMit?<wsp><C>,<S>,<D>	R	0	-
[:SOURce:]FREQuency/?<wsp><C>,<S>,<D>,<P>	RW	0	✓
[:SOURce:]FREQuency:LIMit?<wsp><C>,<S>,<D>	R	0	-
[:SOURce:]OFFset/?<wsp><C>,<S>,<D>,<P>	RW	0	✓
[:SOURce:]OFFset:LIMit?<wsp><C>,<S>,<D>	R	0	-
[:SOURce:]POWer/?<wsp><C>,<S>,<D>,<P>	RW	0	✓
[:SOURce:]ActualPOWer?<wsp><C>,<S>,<D>	R	0	-
[:SOURce:]POWer:LIMit?<wsp><C>,<S>,<D>	R	0	-
[:SOURce:]LIMit?<wsp><C>,<S>,<D>	R	0	-
[:SOURce:]CONFiguration/?<wsp><C>,<S>,<D>,<P>	RW	0	✓
[:SOURce:]BUSY?<wsp><C>,<S>,<D>	R	0	-

Command	Read Write	User access level	Stored if STADEF =0
[:SOURce:] STATe/?<wsp><C>,<S>,<D>,/ <P>	RW	0	✓
[:SOURce:] MONitor?<wsp><C>,<S>,<D>	R	0	-

7.9 SCPI Code error definition

Error #	Description
100	Command Syntax Command error
101	Parameter out of range
102	No data in buffer
103	device not ready
104	user level for this command not sufficient
200	Command execution error
201	user level rights to execute this command not sufficient, increase using PASS command
250	
251	
252	

7.10 Alarm code definition

The following table details potential alarms raised by the unit. The alarm status can be queried using the “alarm?” command. The response is an ASCII coded unsigned 16-bit integer number, little endian. Convert this number into binary format to retrieve the alarm status. Each “1” bit represents an active alarm.

The most common responses to “alarm?” are:

Use the SCPI Command “*cls” to clear all latched alarms.

Bit #	Alarm	Condition/Description
0	Laser Temperature too high	Base temperature of laser exceeds max. threshold. Laser is de-activated to protect Hardware
1	Interlock active	Interlock safety switch located at back of unit is open. This prevents switching on all laser ports
2	Controller communication Failure	Main Controller cannot communicate with other internal components of the unit
3	Laser error	One or more lasers report an error.
4	Not used	
5	Not used	
6	Not used	
7	Not used	
8	Not used	
9	Not used	
10	Not used	
11	Not used	
12	Not used	
13	Not used	
14	Not used	
15	Not used	

8 Copyright

Copyright © 2019 ID Photonics GmbH. All rights reserved. No part of this publication may be reproduced, stored in a retrieval system or transmitted in any form, be it electronically, mechanically, or by any other means such as photocopying, recording or otherwise, without the prior written permission of ID Photonics GmbH.

Information provided by ID Photonics GmbH is believed to be accurate and reliable. However, no responsibility is assumed by ID Photonics GmbH for its use nor for any infringements of patents or other rights of third parties that may result from its use. No license is granted by implication or otherwise under any patent rights of ID Photonics GmbH.

The information contained in this publication is subject to change without notice.