

**Item Number: 6008-1118****Item Description: 888nm, 40W, 400um fiber-coupled module**

Parameter	Units	Minimum	Typical	Maximum
<b>Optical</b>				
CW Output Power from Fiber	W	40		
Center Wavelength	nm	885	888	891
Spectral Width (FWHM)	nm			4
Fiber Core Diameter	µm		400	
Fiber NA	-		0.22	
Temperature tuning coefficient	nm/°C		0.3	
<b>Electrical (FCA)</b>				
Operating Current (I <sub>OP</sub> )	A		55	60
Operating Voltage (V <sub>OP</sub> )	V		1.6	1.7
E-O conversion efficiency	%		45	
<b>Thermal</b>				
Operating Temperature	°C	20	25	30
Storage Temperature	°C	-20		70
<b>Mechanical</b>				
Module dimensions	mm		88 x 40 x 36	
Fiber length	m		2	
Fiber Input connector	-		HP-SMA 905	
<b>Thermistor</b>				
Type	-		NTC	
Resistance at 25°C	KΩ		10	
<b>Optional Aiming Beam</b>				
Wavelength	nm			635 +/- 10
Optical power	mW			>=1.0
<b>Optional Monitoring Photo Diode</b>				
Output signal at full power	µA	50		250
<b>Control signal</b>				
Interfacing	DB-15 connector at module back wall			

**Notes**

1. Specified performance to be tested at 25C module base temperature
2. Non-condensing operating environment required

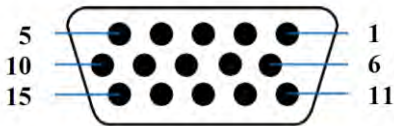
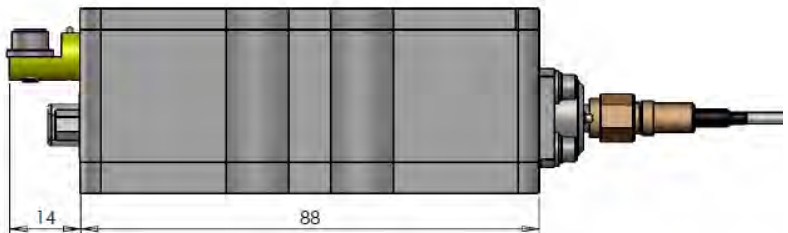
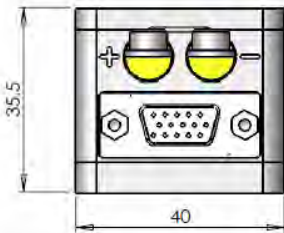
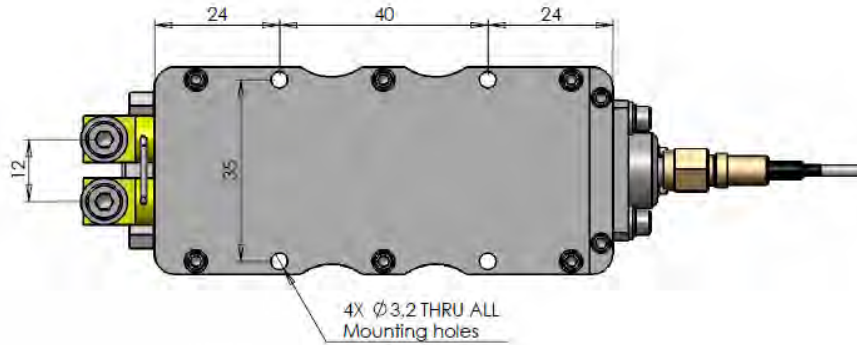

Pin number	Assignment
1	Not used
2	Not used
3	Aiming beam "+"
4	Aiming beam Ground
5	Monitor Photodiode "+"
6	Monitor Photodiode "-"
7	Not used
8	Not used
9	Not used
10	Not used
11	Not used
12	Not used
13	Not used
14	Thermistor (NTC)
15	Thermistor (NTC)

