

*This product is sold
and supported
in the USA by*



LASER LAB SOURCE
marketplace for **Scientists & Engineers**

Laser Diode Part Number: 1490LD-1-0-0

contact@laserlabsource.com | 800-887-5065

1470 nm laser diode - DFB

Model 1 : >10 mW / singlemode fiber / 14 pin Butterfly package

Reference: 1470LD-1-0-0-1 or 2 (SMF or PM)

Technology : DFB*

SPECIFICATIONS	Unit	Min	Typ	Maximum
Output Power (CW mode)	mW	10		
Output Power (Pulse mode)	mW		15	
Center Wavelength (CW)**	nm	1465	1470	1475
Spectral Width (FWHM)	kHz		1 000	2 000
Threshold Current	mA		8	20
Operating Current	mA		60	70
Operation Voltage	V		1.6	1.8
Wavelength shift w Temperature	nm/°C		0.08	
Wavelength shift w Current	nm/mA		0.003	
Side mode suppression ratio	dB	35	50	
Internal Photodiode Responsivity	mA/W	5		
Internal Photodiode Dark Current	nA			500
TEC current (-5/60°C)	A			1
TEC Voltage (-5/60°C)	V			1.5
Internal thermistor (25°C)	kOhm	9.5	10	10.5
Fiber type	PM1550 or equivalent			
Coating diameter	µm		900	
Fiber bend radius	mm			30
Storage case temperature	°C	-40 (abs min)		70 (abs max)
Case operating temperature	°C	-20		60
Lead soldering temperature	°C		260	300
Laser diode reverse voltage	V			15
Pigtail termination	FC/APC connector			
Polarization state (if PM version)	Aligned to the slow axis			

*: See our tutorial : [fiber coupled laser diode](#)

Form factor & Laser diode pinning (standard 14-pin Butterfly Type-1) :

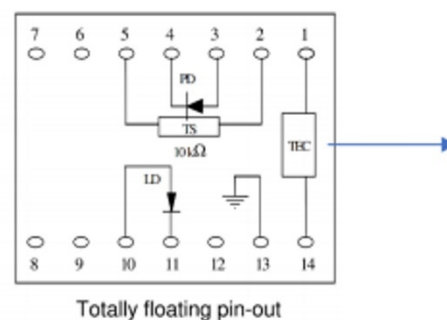
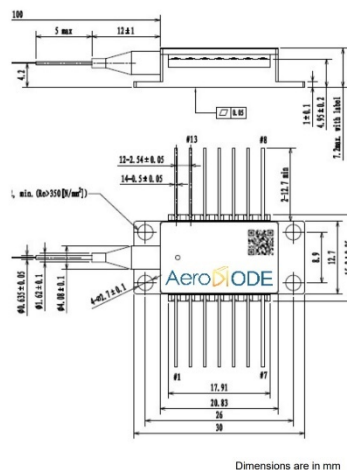

NOTE : Other pin configuration available on demand (Type-2, Type-2 Bias-T etc.)

