

EYP-RWE-0760-02010-1500-SOT12-0000

Revision 1.02

2019-03-01

GAIN CHIPS AR coated Fabry-Perot Laser

General Product Information

Product	Application
tunable 760 nm Fabry-Perot Laser	Spectroscopy
for use in an External Cavity Diode Laser (ECDL)	covering wavelengths between
sealed SOT Housing	752 and 772 nm
Monitor Diode	

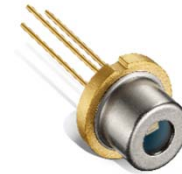

Absolute Maximum Ratings

Parameter	Symbol	Unit	min	typ	max
Storage Temperature	T_S	°C	-40		85
Operational Temperature at Case	T_C	°C	-20		50
Forward Current	I_F	mA			200
Reverse Voltage	V_R	V			0
Output Power (ex-cavity)	P_{opt}	mW			100

Measurement Conditions / Comments

Stress in excess of the Absolute Maximum Ratings can cause permanent damage to the device.

Recommended Operational Conditions

Parameter	Symbol	Unit	min	typ	max
Operational Temperature at Case	T_C	°C	15		40
Forward Current	I_F	mA			180

Measurement Conditions / Comments

Characteristics ex-cavity at $T_C=25^\circ\text{C}$, at BOL under recommended working condition

Parameter	Symbol	Unit	min	typ	max
Center Wavelength	λ_c	nm		760	
Tuning Range	$\Delta\lambda_{tun}$	nm	752		772
Output Power	P_{opt}	mW		80	
Polarization				TM	
Spatial Mode (transversal)				TEM ₀₀	

Measurement Conditions / Comments

The actual achieved wavelength and power are strongly influenced by the external cavity. eyP gives no guarantee on these parameters.

E field perpendicular to Pin 2 - Pin 3 - plane
Fundamental Mode

EYP-RWE-0760-02010-1500-SOT12-0000

Revision 1.02

2019-03-01

GAIN CHIPS AR coated Fabry-Perot Laser



Amplified Spontaneous Emission (ASE)

without external cavity

Parameter	Symbol	Unit	min	typ	max
Divergence parallel (FWHM)	$\Theta_{ }$	°		10	
Divergence perpendicular (FWHM)	Θ_{\perp}	°		28	
Monitor Detector Responsivity	$I_{\text{mon}} / P_{\text{ASE}}$	$\mu\text{A/mW}$	1		40

Measurement Conditions / Comments

Full angle, parallel to Pin 2 - Pin 3 plane (see p. 3)

Full angle, perpendicular to Pin 2 - Pin 3 plane (see p. 3)

 $U_{\text{R MD}} = 5 \text{ V}$

Chip Parameter

Parameter	Symbol	Unit	min	typ	max
Cavity Length	L	μm		1500	
Reflectivity at Front Facet	R_{ff}			$3 \cdot 10^{-4}$	$1 \cdot 10^{-3}$

Measurement Conditions / Comments

EYP-RWE-0760-02010-1500-SOT12-0000

Revision 1.02

2019-03-01

GAIN CHIPS AR coated Fabry-Perot Laser

Package Dimensions

Parameter	Symbol	Unit	min	typ	max
Height of Emission Plane	h	mm	3.50	3.65	3.70
Excentricity of Emission Center	R	mm			0.12
Pin Length	L _{PIN}	mm		14	

Measurement Conditions / Comments

reference plane: top side of TO header
reference: center of outer diameter of header

Package Pinout

- 1 Laser Diode Anode, Monitor Diode Cathode, Case
- 2 Photo Diode Anode
- 3 Laser Diode Cathode

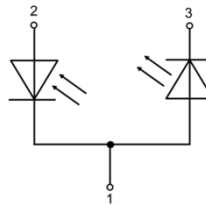

Bottom View

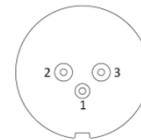

Package Drawings

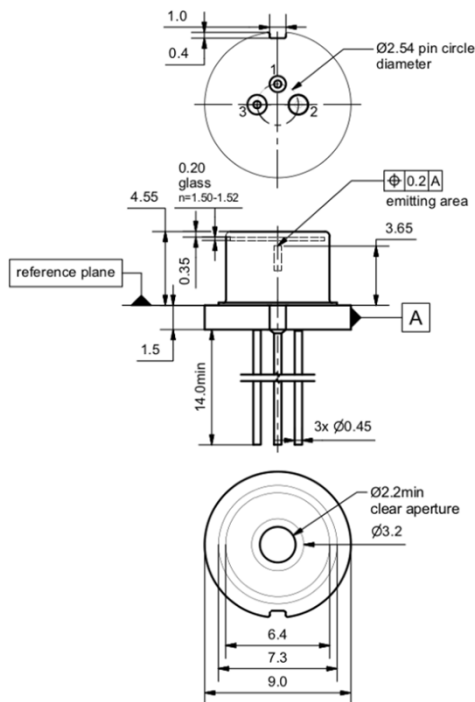

AIZ-16-0421-1517



EYP-RWE-0760-02010-1500-SOT12-0000

Revision 1.02

2019-03-01

GAIN CHIPS AR coated Fabry-Perot Laser

Typical Measurement Results ex-cavity

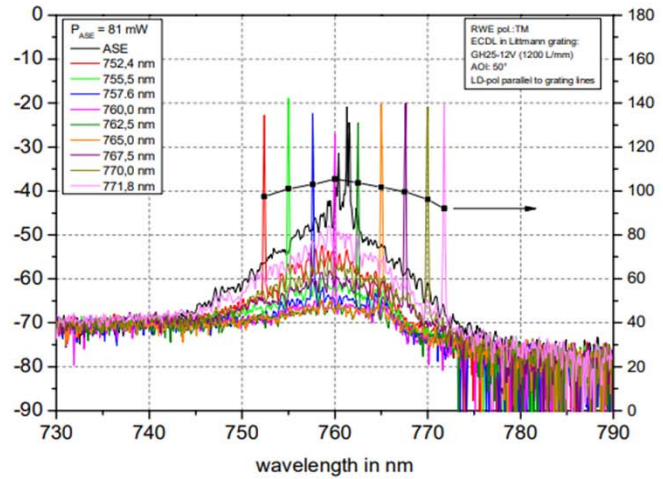
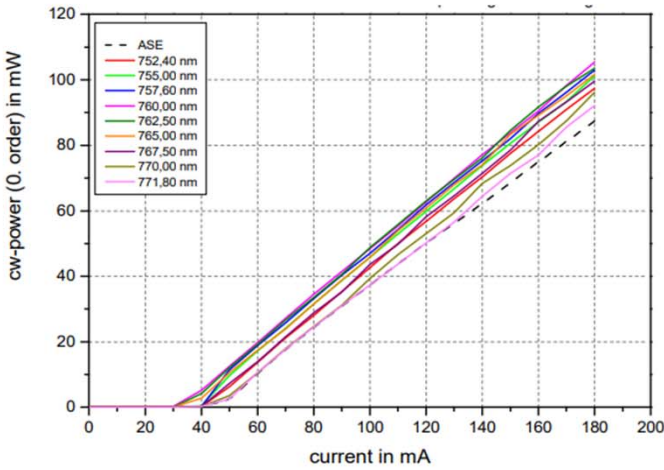

Performance figures, data and any illustrative material provided in this specification are typical and must be specifically confirmed in writing by eagleyard Photonics before they become applicable to any particular order or contract. In accordance with the eagleyard Photonics policy of continuous improvement specifications may change without notice.

Unpacking, Installation and Laser Safety

Unpacking the laser diodes should only be done at electrostatic safe workstations (EPA). Though protection against electrostatic discharge (ESD) is implemented in the laser package, charges may occur at surfaces. Please store this product in its original package at a dry, clean place until final use. During device installation, ESD protection has to be maintained.

The TPA diode type is known to be sensitive against thermal stress. It should not be operated without appropriate injection from a seed laser. Operating at moderate temperatures on proper heat sinks will contribute to a long lifetime of the diode. The chip should be protected against moisture. A water vapor content below 5000 ppm is recommended for applications with high reliability requirements.

The laser emission from this diode is close to the invisible infrared region of the electromagnetic spectrum. Avoid direct and/or indirect exposure to the free running beam. Collimating the free running beam with optics as common in optical instruments will increase threat to the human eye.

Each laser diode will come with an individual test protocol verifying the parameters given in this document.

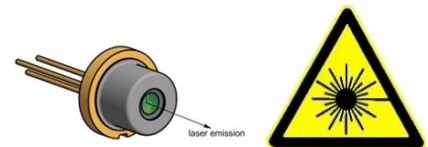

IEC-60825-0

