

AlGaInP Red Laser Diode

ADL-63V01CZ

6-2D-LD63-003 Rev.00

★635nm 0.5W 30°C C-Mount PKG

•Features

1. High power
2. High brightness
3. Long lifetime
4. Narrow spectral line-width
5. High polarization purity

•Applications

1. Laser display
2. PDT
3. Biochemistry
4. Military
5. Solid-state laser pumping
6. Material processing
7. Medical/Life and health sciences
8. Illumination

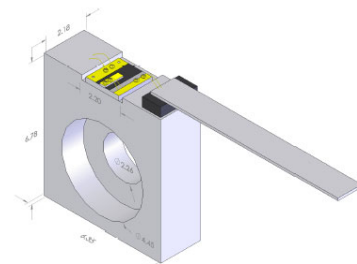
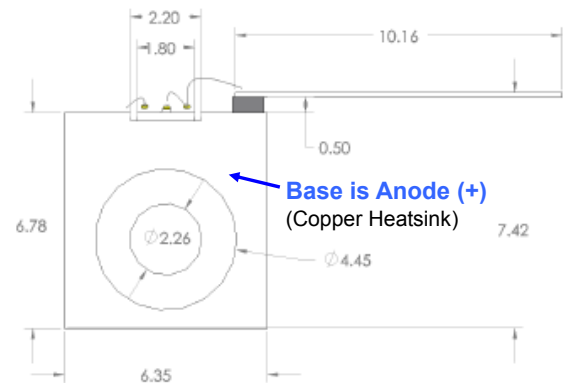
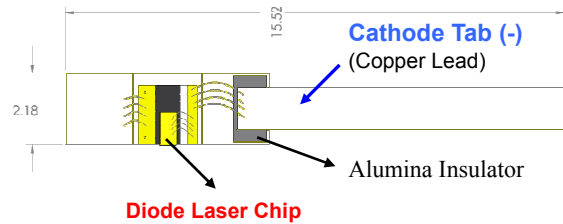

※ Dimensions are in mm.

•Absolute maximum ratings

Parameter	Symbol	Condition	Rating	Unit
Light output power	P_O	CW	600	mW
Reverse voltage (LD)	V_{RL}	-	2	V
Case temperature	T_C	-	-10~+30	°C
Storage temperature	T_S	-	-40~+85	°C

•Electrical and optical characteristics ($T_c=25^\circ\text{C}$)

Parameter	Symbol	Min.	Typ.	Max.	Unit	Conditions
Peak wavelength	λ	630	636	640	nm	$P_o=500\text{mW}$
Wavelength Temperature Coefficient			0.25	0.3	nm/°C	$P_o=500\text{mW}$
Emitter size		-	50	-	um	
Polarization			TM			
Threshold current	I_{th}	-	200	300	mA	
Operating current	I_{op}	-	700	1000	mA	$P_o=500\text{mW}$
Operating voltage	V_{op}	-	2.5	3.0	V	$P_o=500\text{mW}$
Differential efficiency	η	-	1.0	-	mW/mA	$P_o=300\text{-}500\text{mW}$
Parallel divergence angle	$\theta_{ }$	-	3.5	12	deg	$P_o=500\text{mW}$
Perpendicular divergence angle	θ_{\perp}	30	36	40	deg	
Total conversion efficiency		-	28	-	%	

•Precautions

- * Do not operate the device above maximum ratings. Doing so may cause unexpected and permanent damage to the device.
- * Take precautions to avoid electrostatic discharge and/or momentary power spikes. A change in the characteristics of the laser or premature failure may result.
- * Proper heat sinking of the device assures stability and lifetime. Always ensure that maximum operating temperatures are not exceeded.
- * Observing visible or invisible laser beams with the human eye directly, or indirectly, can cause permanent damage. Use a camera to observe the laser.
- * No laser device should be used in any application or situation where life or property is at risk in event of device failure.
- * Specifications are subject to change without notice. Ensure that you have the latest specification by contacting us prior to purchase or use of the product.

* For reference only. Contents above are subject to change without notice.

Arima
LASERS

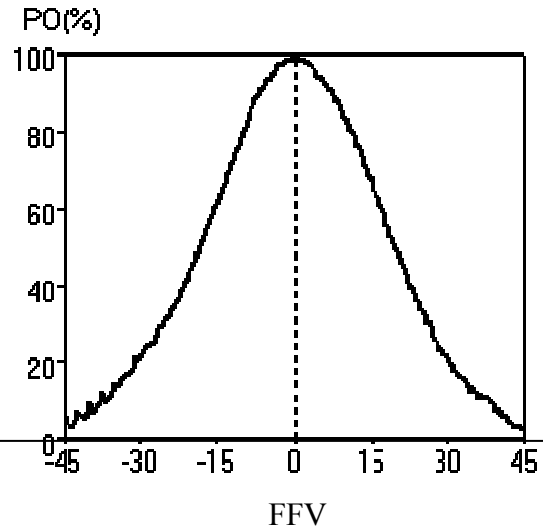
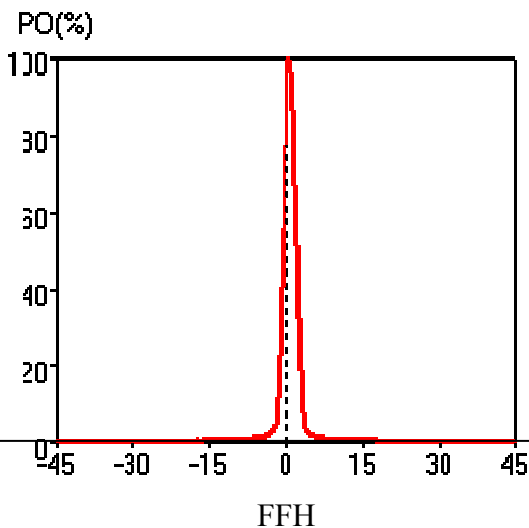
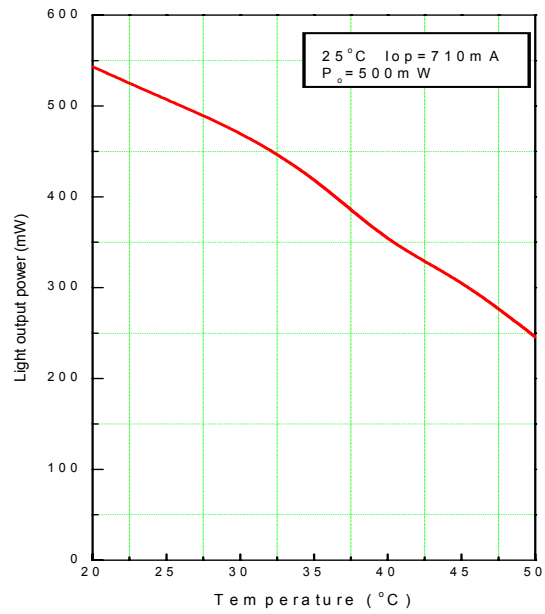
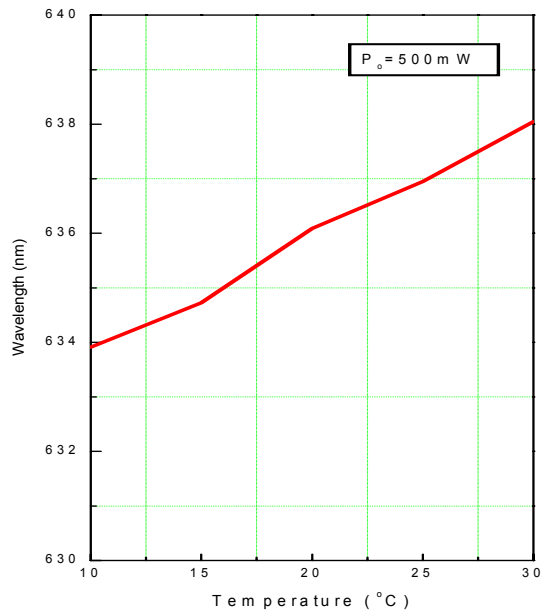
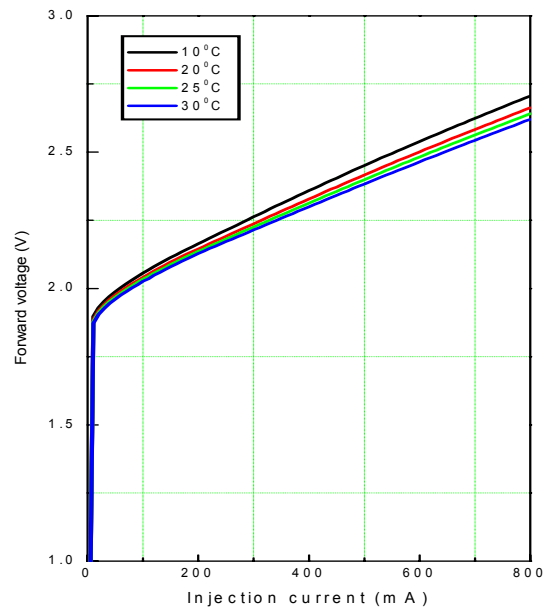
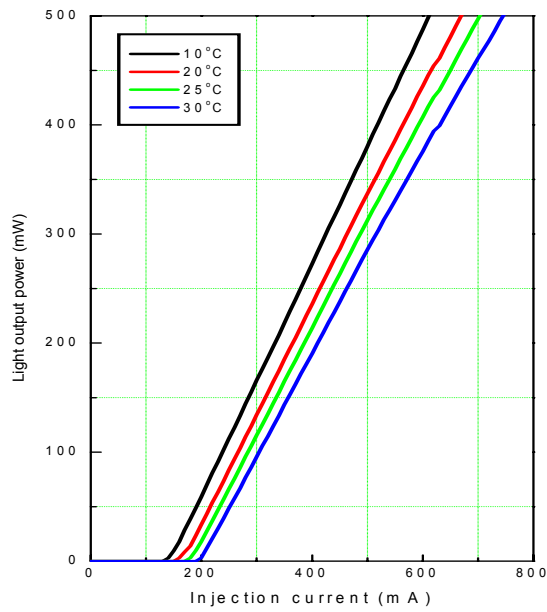

* For reference only. Contents above are subject to change without notice.