

**Datasheet for #BG-7-8**

Recommendations:

Please read the starter kit user manual, if available, and have a look at the FAQ at <http://www.alpe lasers.ch/alfa q.pdf>

**WARNING:** Operating the laser with longer pulses, higher repetition rate, higher voltage or higher current than specified in this document may cause damage. It will result in loss of warranty, unless agreed upon with Alpes Lasers!

**WARNING:** Beware of the polarity of the laser. This laser has to be powered with negative bias on the laser contact (= bonding pad, corresponding to the label "laser" on the LLH) and the positive bias on the base contact (= submount, corresponding to the label "base" on the LLH).

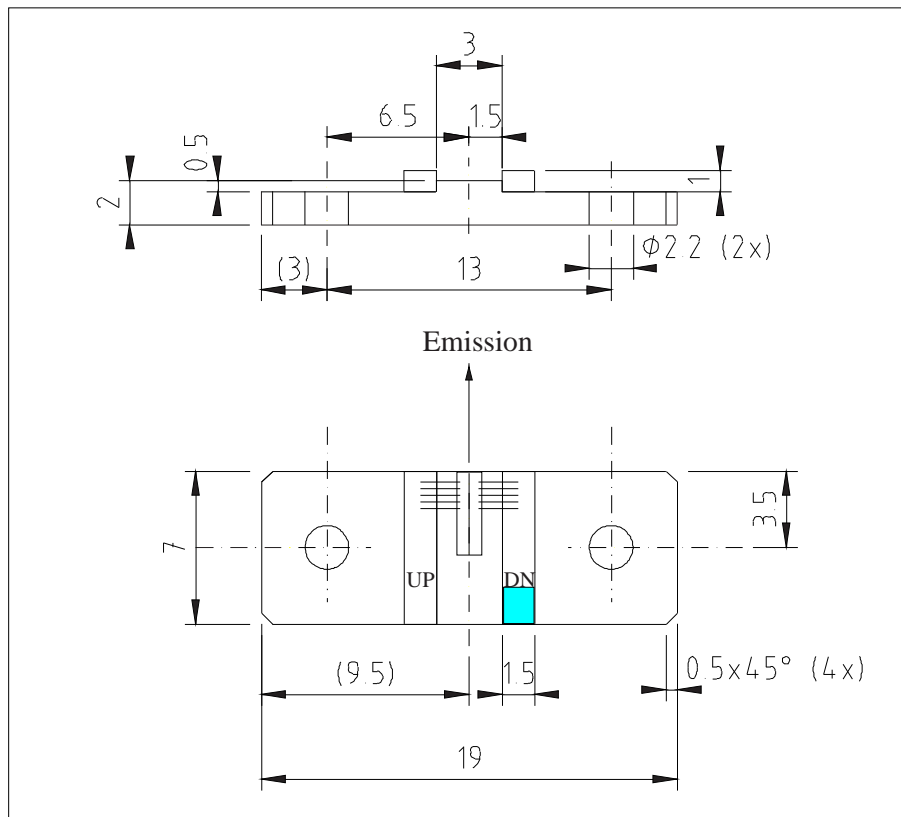

Figure 1: Support mounting for #BG-7-8 (please note that the laser is connected to the DN pad drawn in blue)

# Performances of the uncoated / uncoated laser

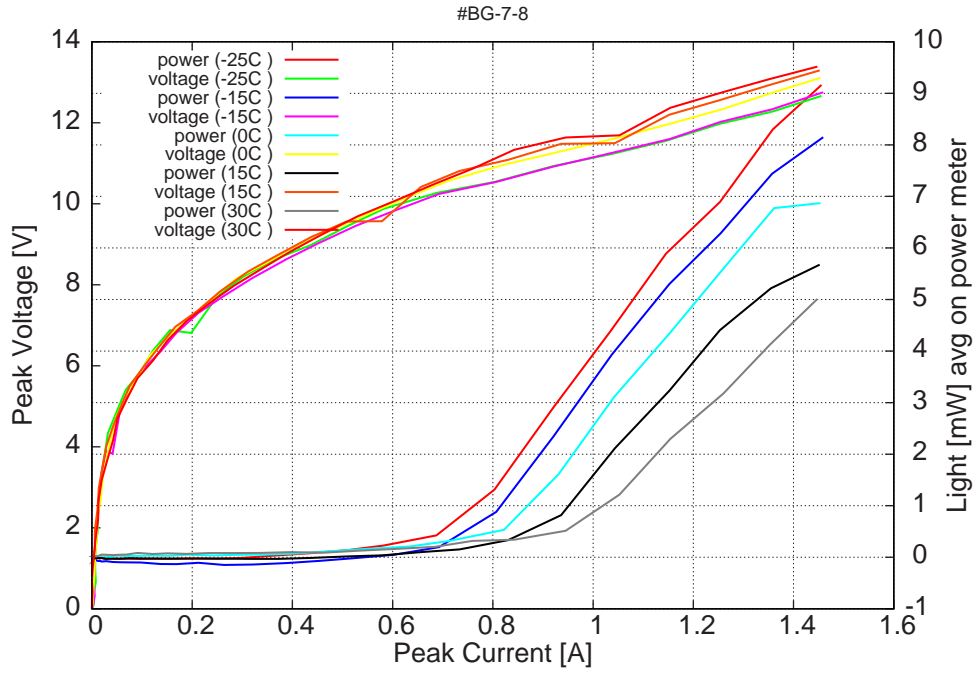

Figure 2: peak voltage and average power vs peak current at 2% duty-cycle (100ns pulses on the laser, 5 $\mu$ s period) for the uncoated laser

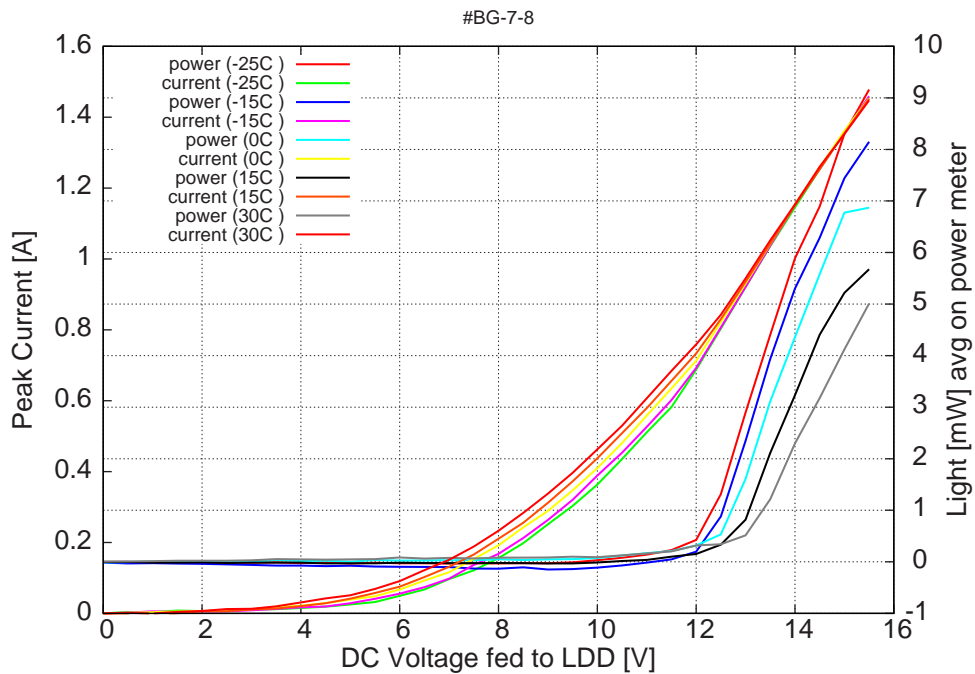

Figure 3: peak current and average power vs LDD voltage at 2% duty-cycle (100ns pulses on the laser, 5 $\mu$ s period) for the uncoated laser

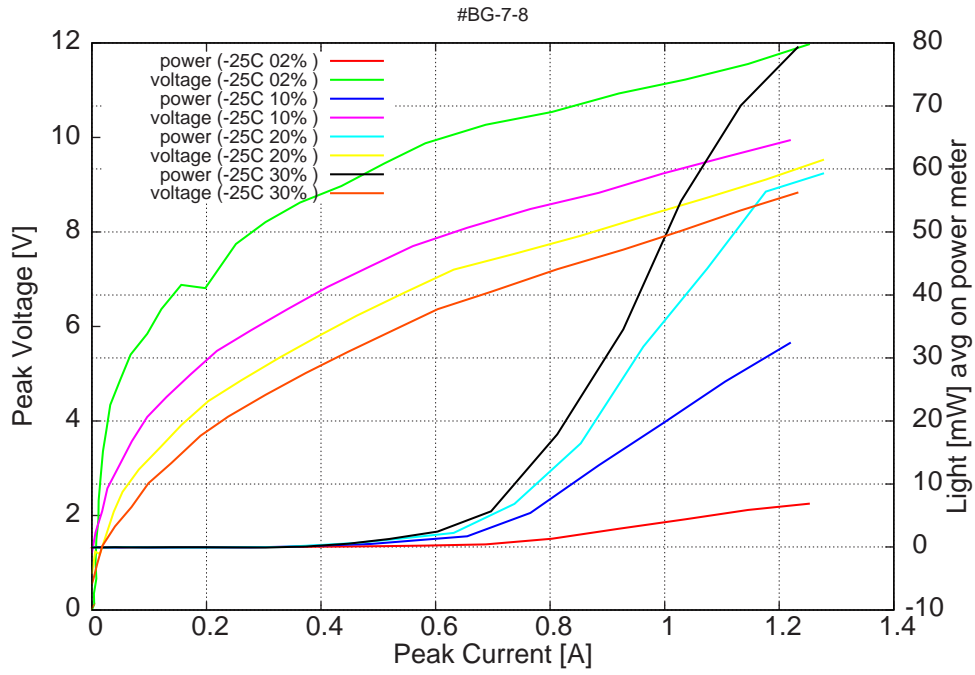

Figure 4: peak voltage and average power vs peak current at -25C for various duty-cycle (100ns pulses on the laser) for the uncoated laser

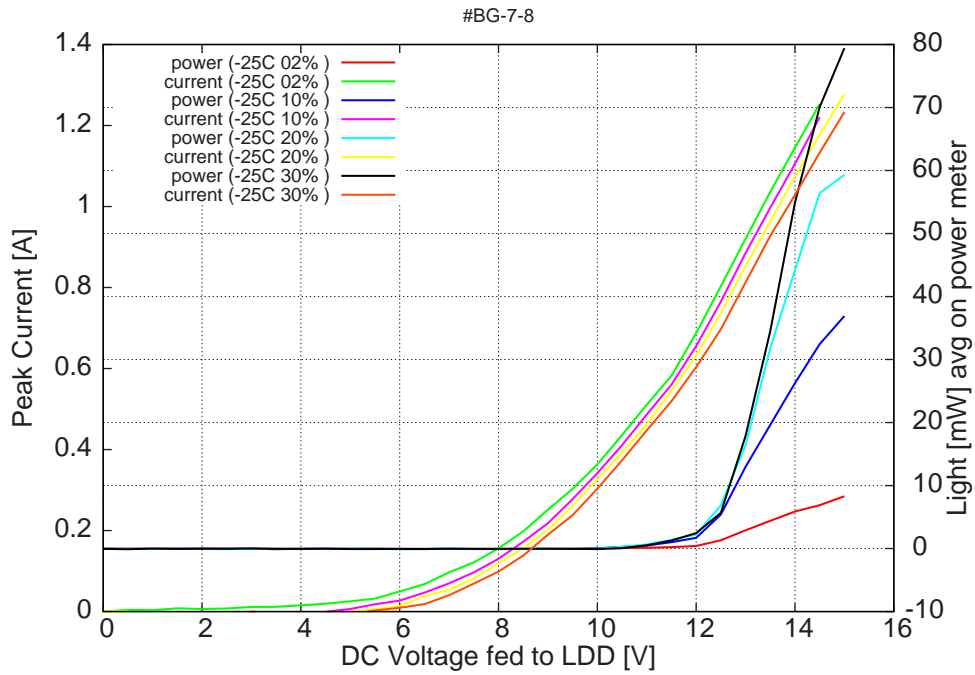
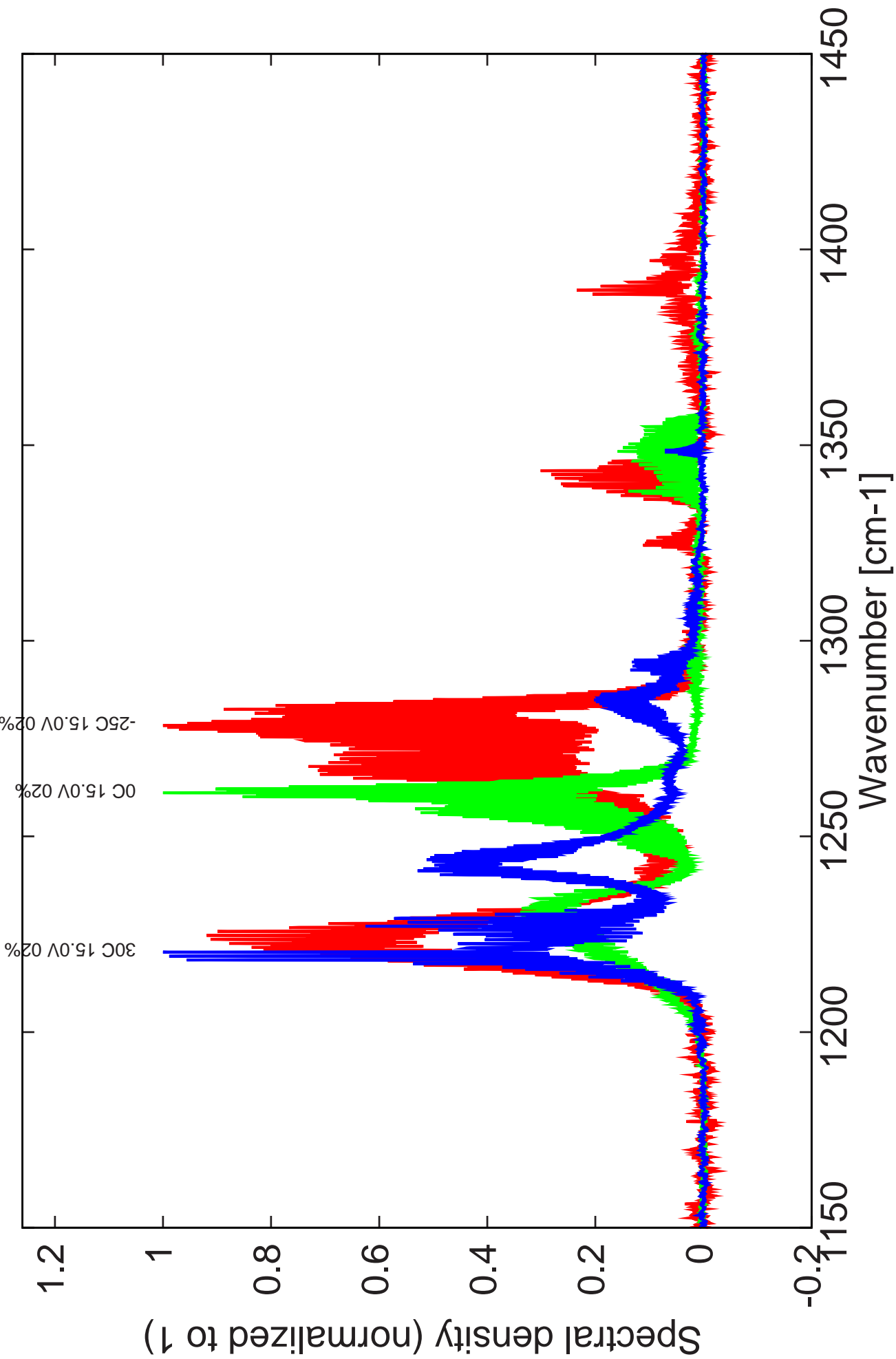

Figure 5: peak current and average power vs LDD voltage at -25C for various duty-cycle (100ns pulses on the laser) for the uncoated laser

Figure 6: spectra at -25C, 0C and 30C at 2% duty-cycle for various LDD voltages for the uncoated laser



Performances of the laser while uncoated on front-facet / HR coated on back-facet

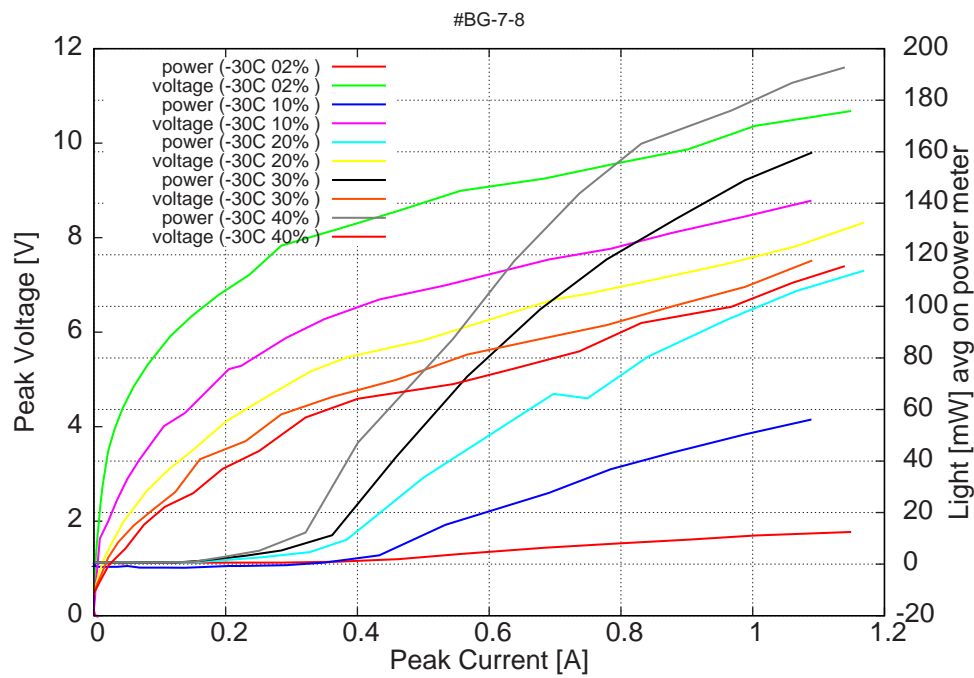

Figure 6: peak voltage and average power vs peak current at -30C for various duty-cycle (100ns pulses on the laser) for the HR coated laser

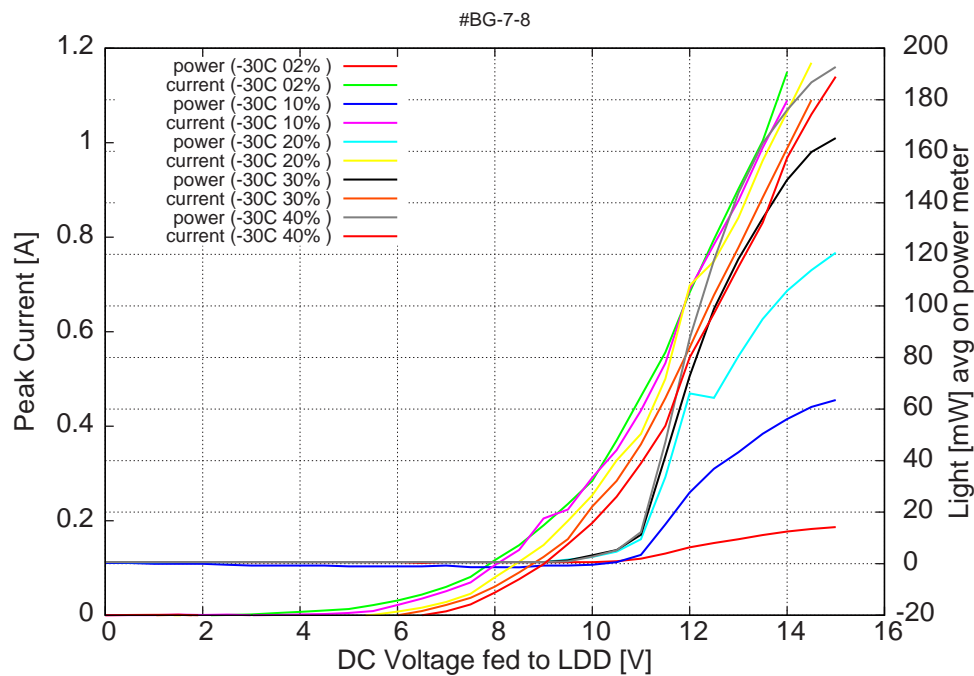

Figure 7: peak current and average power vs LDD voltage at -30C for various duty-cycle (100ns pulses on the laser) for the HR coated laser

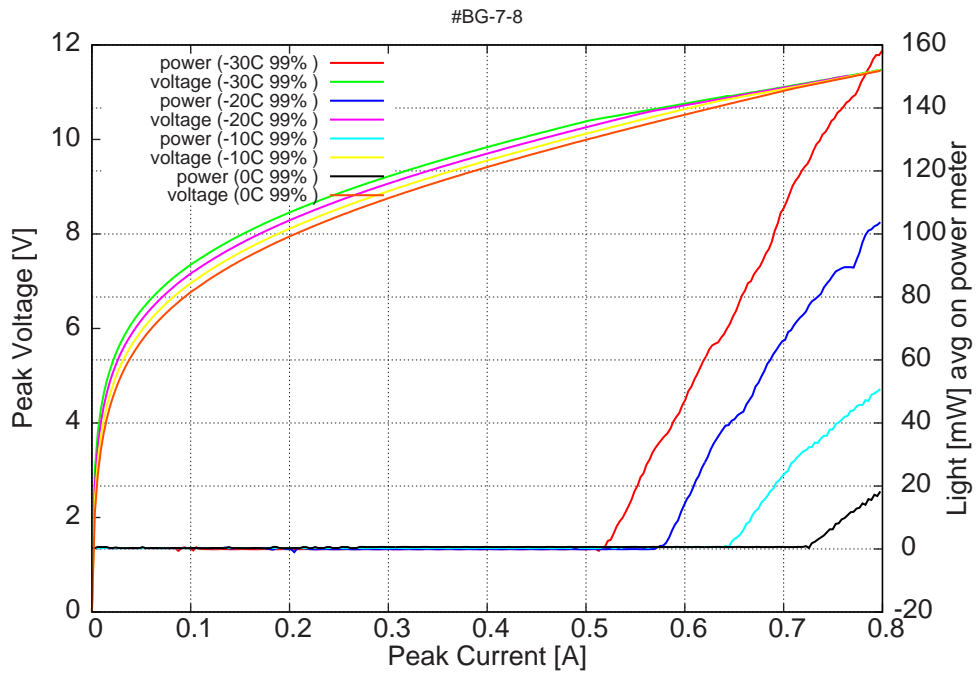

Figure 8: voltage and avg power vs current in continuous-wave operation for the HR coated laser

Figure 10: spectrum at -30C in continuous-wave operation for the HR coated laser

