

# QSI LASER DIODE SPECIFICATIONS FOR APPROVAL

Customer :.

Model : QL65F6S-A/B/C

**Signature of Approval**

Approved by \_\_\_\_\_

Checked by \_\_\_\_\_

Issued by \_\_\_\_\_

**Approval by Customer**

---



QSI Co., Ltd.

315-9, Cheonheung-ri, Sungger-eup,  
Cheonan-city, Chungnam, Korea 330-836

[WWW.QSILaser.com](http://WWW.QSILaser.com)

# QL65F6S-A/B/C

## InGaAIP Laser Diode

Quantum Semiconductor International Co., Ltd.

Ver. 0 JAN. 2004

### ◆ OVERVIEW

QL65F6S-A/B/C is a MOCVD grown 650nm band *InGaAIP* laser diode with quantum well structure. It's an attractive light source, with a typical light output power of 10mW and low operating current for optoelectronic devices such as Optical Pick-up & Bar Code Reader.

### ◆ APPLICATION

- Optical Pick-up
- Laser Module
- Bar Code Reader

### ◆ FEATURES

- Visible Light Output :  $\lambda_p = 650 \text{ nm}$
- Optical Power Output : 10mW CW
- Package Type : TO-18 (5.6mm $\phi$ )
- Built-in Photo Diode for Monitoring Laser Diode

### ◆ ELECTRICAL CONNECTION

#### Bottom View

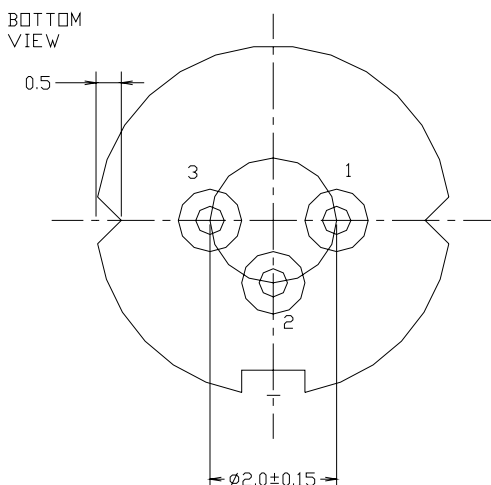

#### Pin Configuration

A	LD cathode, PD anode (Fig. 1)
B	LD , PD anode (Fig. 2)
C	LD anode, PD cathode (Fig. 3)

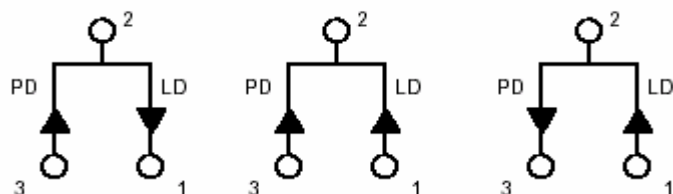

Fig. 1

QL65F6SA

Fig. 2

QL65F6SB

Fig. 3

QL65F6SC

◆ ABSOLUTE MAXIMUM RATING at Tc=25°C

Items	Symbols	Values	Unit
Optical Output Power	P	12	mW
Laser Diode Reverse Voltage	V	2	V
Photo Diode Reverse Voltage	V	30	V
Operating Temperature	Topr	-10 ~ +60	°C
Storage Temperature	Tstg	-40 ~ +85	°C

◆ ELECTRICAL and OPTICAL CHARACTERISTICS at Tc=25°C

Items	Symbols	Min.	Typ.	Max.	Unit	Condition
Optical Output Power	Po	-	10	-	mW	-
Threshold Current	Ith	-	40	50	mA	-
Operating Current	Iop	-	60	80	mA	Po=10mW
Operating Voltage	Vop	-	2.3	2.6	V	Po=10mW
Lasing Wavelength	$\lambda_p$	645	655	660	nm	Po=10mW
Beam Divergence	$\theta_{  }$	6	9	12	deg	Po=10mW
	$\theta_{\perp}$	24	28	35	deg	Po=10mW
Beam Angle	$\Delta\theta_{  }$	-	-	±1.5	deg	Po=10mW
	$\Delta\theta_{\perp}$	-	-	±2.5	deg	Po=10mW
Monitor Current	I <sub>m</sub>	0.1	0.2	0.5	mA	Po=10mW
Optical Distance	$\Delta X, \Delta Y, \Delta Z$	-	-	±60	μm	-

**NOTICE : QL65F6S-A/B/C to be operated on APC**

The above product specifications are subject to change without notice.

◆ EXAMPLE of REPRESENTATIVE CHARACTERISTICS

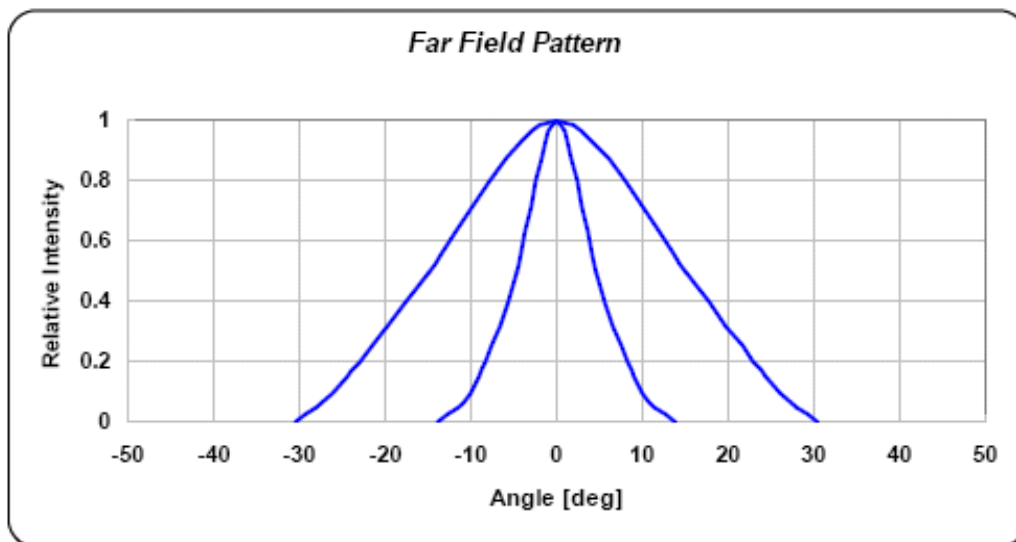
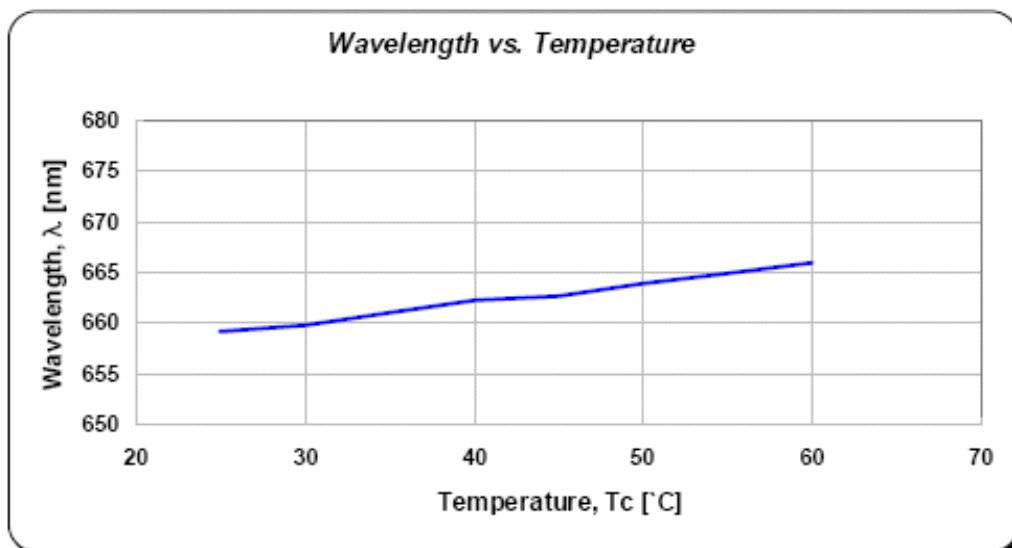
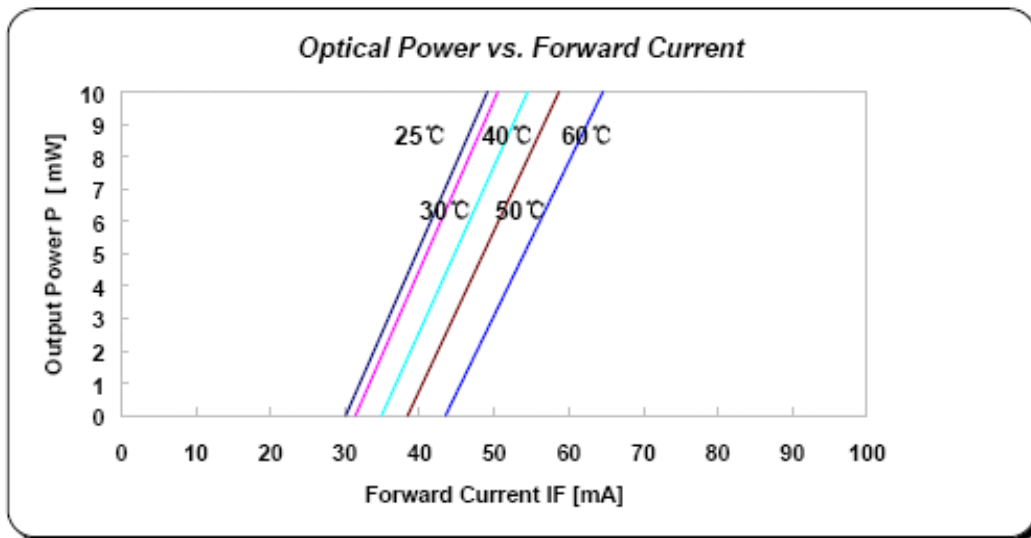

*Monitor Current vs. Optical Output Power*

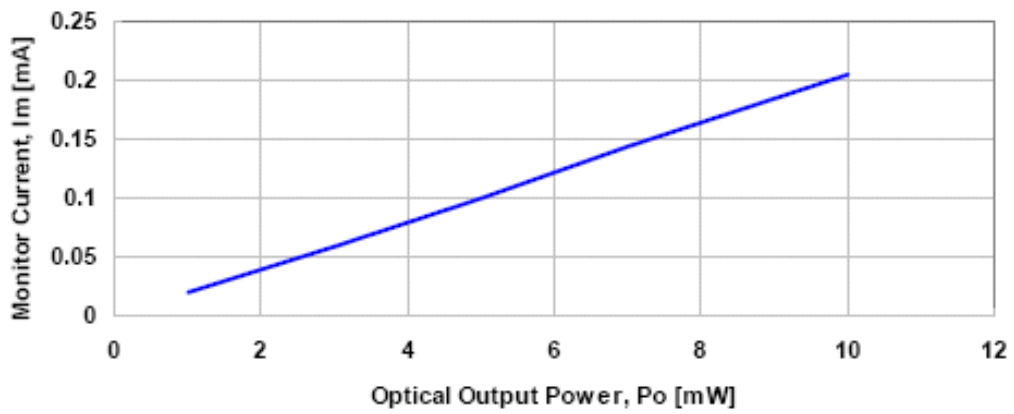

*Operating Voltage vs. Temperature*

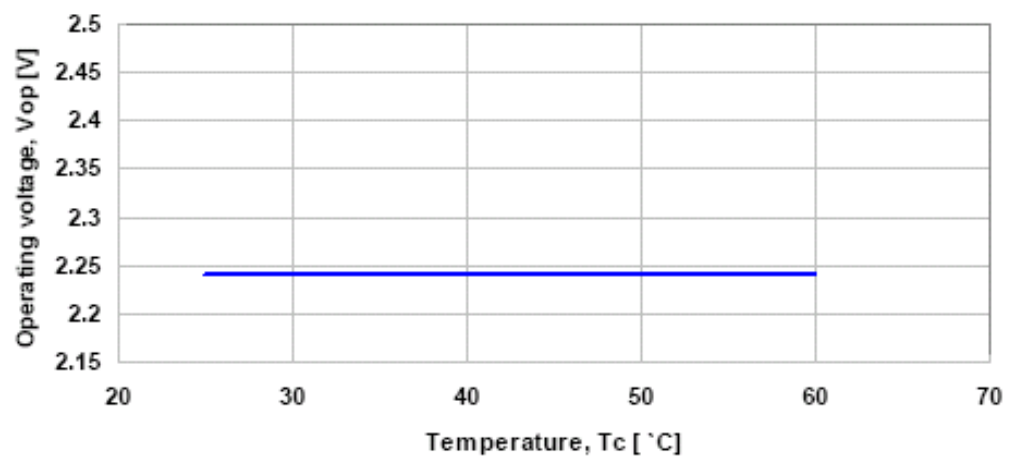

*Threshold Current vs. Temperature*

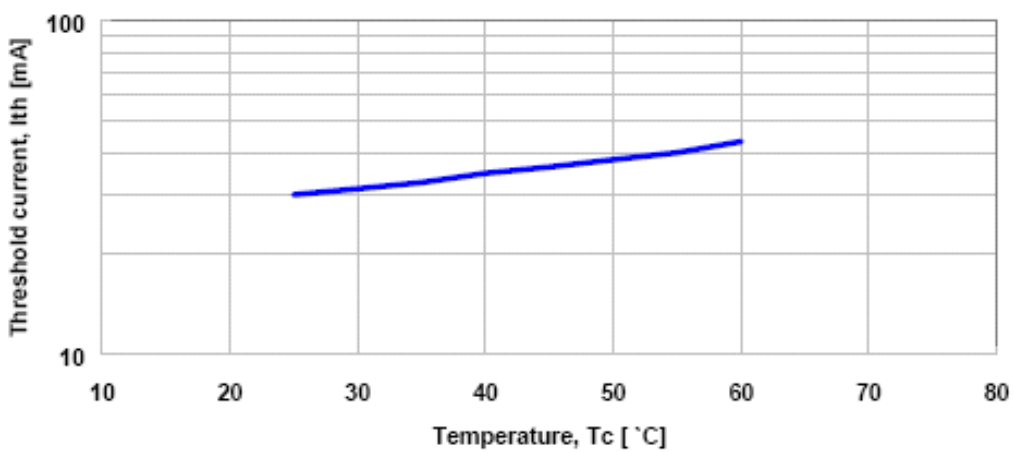

# ◆ PACKAGE DIMENSION

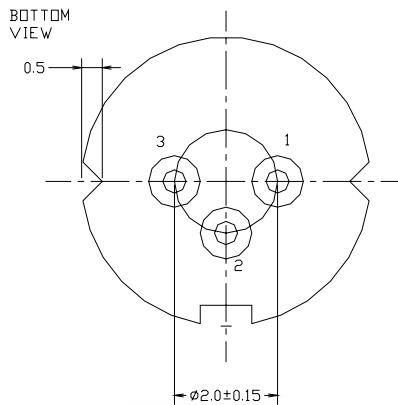
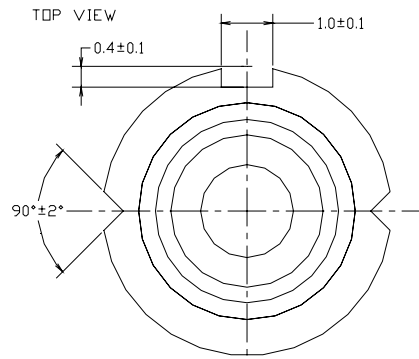
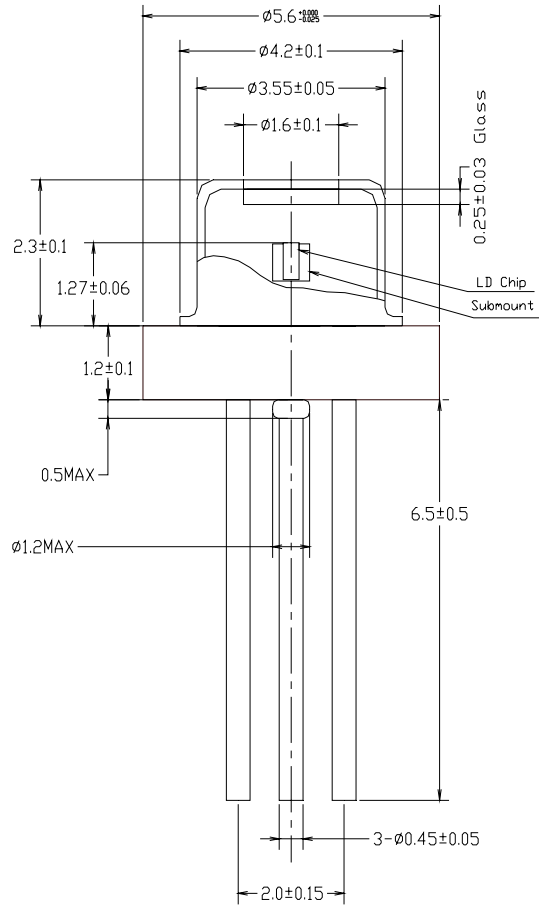

◆PACKING

