

# LDI-1310-FP-1.25G-20/100

## OVERVIEW

LDI-1310-FP-1.25G-20/100 is an InGaAsP MQW laser diode coupled to an optical fiber

## MAIN FEATURES

- Wavelength: 1310 nm
- Cavity type: Fabry-Perot
- Data rate up to 1.25 Gbps
- Optical power: up to 20 mW in CW mode and up to 100 mW in pulse mode in the single-mode fiber G.657.A1
- Package types: coaxial
- Built-in monitor photodiode

## APPLICATIONS

- Optical fiber communication systems with data rate up to 1.25 Gbps, OTDR
- Laser systems

## ORDERING INFORMATION

### LDI-1310-FP-1.25G-20/100-X-2-X-X-X

#### Case type

**U:** compact coaxial (pulse mode only)  
**B:** compact coaxial with double-sided bracket  
 It is necessary to provide heat removal from the case

#### Fiber type

**SM1:** G.657.A1, furcation tubing  $\varnothing$ 0.9 mm  
**SM3:** G.657.B3, furcation tubing  $\varnothing$ 0.9 mm  
**MM5:** 50/125 OM2, furcation tubing  $\varnothing$ 0.9 mm  
**MM6:** 62.5/125 OM1, furcation tubing  $\varnothing$ 0.9 mm  
 Standard fiber length 50 cm  
 Other type and length: on request

#### Connector type

**FU:** FC/UPC  
**FA:** FC/APC  
**N:** no connector  
 Other types: on request

#### Certification

**CW:** CW mode,  
**P:** pulse mode,  
**CWP:** both CW and pulse mode

This document was updated on 03.05.2019

# LDI-1310-FP-1.25G-20/100

## ABSOLUTE MAXIMUM RATINGS

Parameter		Value	Unit	Conditions
Laser diode forward current	$I_{FL}$	150	mA	CW
		500		Pulse
Laser diode reverse voltage	$V_{RL}$	2	V	
Photodiode reverse voltage	$V_{RP}$	20	V	
Photodiode forward current	$I_{FP}$	2	mA	
Operating temperature	$T_{op}$	-40 ÷ +85	°C	Package U, B
Storage temperature	$T_{stg}$	-50 ÷ +85	°C	
Soldering temperature	$T_{sold}$	260	°C	Max. 10 seconds

## ELECTRICAL-OPTICAL CHARACTERISTICS (T = 25 °C)

Parameter		Min	Typ	Max	Unit	Conditions
Wavelength	$\lambda$	1290	1310	1330	nm	CW, P = 20 mW
Spectral width	$\Delta\lambda$		1.2	2.5	nm	CW, P = 20 mW, -20 dB
			10	20		Pulse, P = 100 mW
Wavelength-temperature coeff.	$d\lambda/dT$		0.5		nm/°C	
Threshold current	$I_{th}$		7	12	mA	CW
Operating current	$I_{op}$		75	90	mA	CW, P = 20 mW
Pulse optical power	$P_P$	85	100		mW	Pulse, $I_{op} = 450$ mA
Operating voltage	$V_{op}$		1.4	1.8	V	CW, P = 20 mW
Slope efficiency	$S_e$	0.24	0.28		mW/mA	CW
Tracking error	$E_r$		0.4	0.6	dB	CW, P = 3 mW, T = -40 ÷ +80 °C, SM1, SM3
Rise and fall times	$t_r, t_f$		100	240	ps	20% - 80%, Package U, B
Monitoring output current (PD)	$I_m$	0.2	0.5	3	mA	CW, P = 20 mW, $V_{rd} = 5$ V
Capacitance (PD)	$C_t$		10	20	pF	$V_{rd} = 5$ V, f = 1 MHz
Dark current (PD)	$I_d$			100	nA	$V_{rd} = 5$ V

Pulse mode: pulse duration 10  $\mu$ s, duty cycle = 0.01

Tracking error  $E_r = \max|10 \lg[P(T)/P(25^\circ\text{C})]|$ ,  $I_m = \text{const}$ ,  $T = T_{min} \div T_{max}$

# LDI-1310-FP-1.25G-20/100

## CHARACTERISTICS (T = 25 °C)

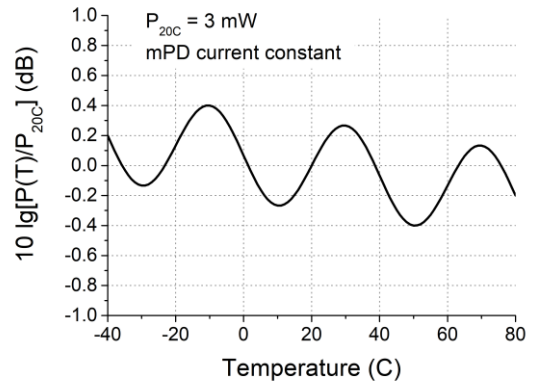
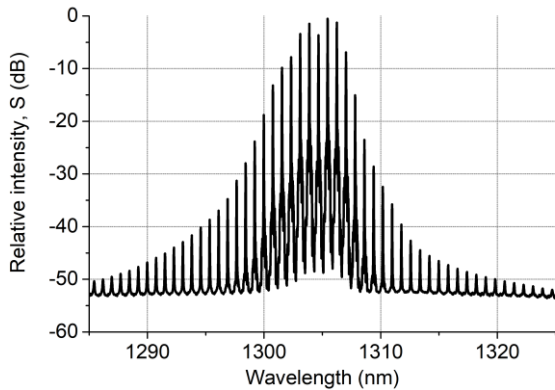
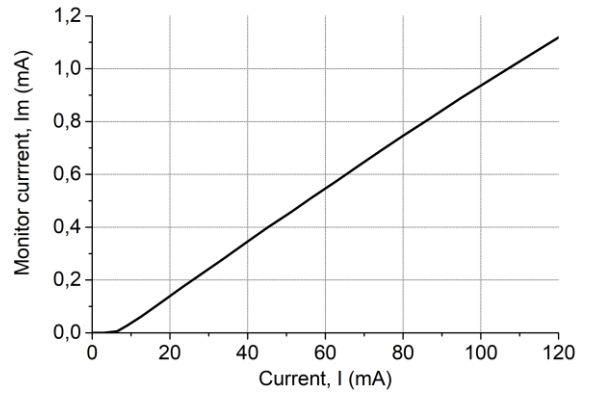
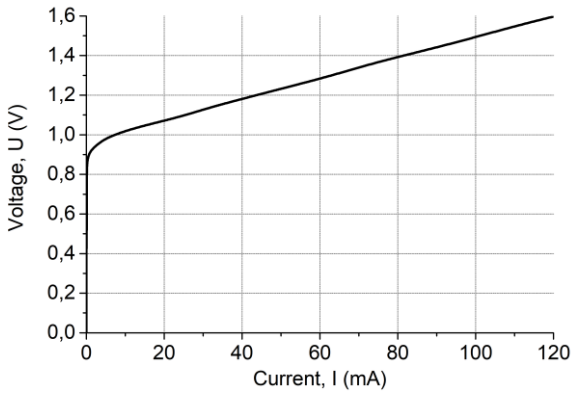
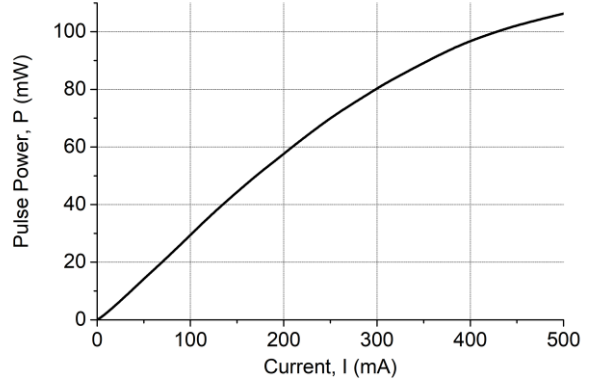
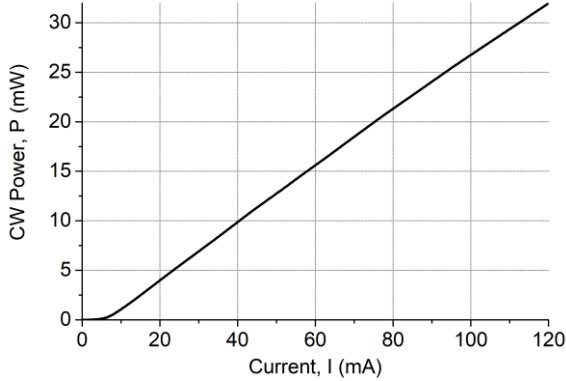

# LDI-1310-FP-1.25G-20/100

## PACKAGE TYPE AND ELECTRICAL CONNECTION

U

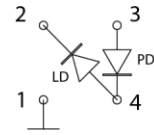
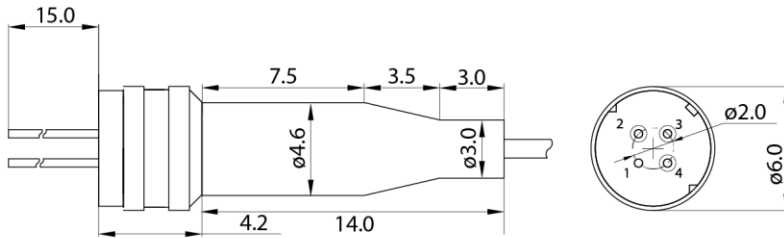

1. Case
2. LD Cathode
3. PD Anode
4. LD Anode, PD Cathode

B

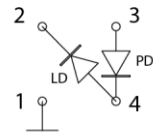
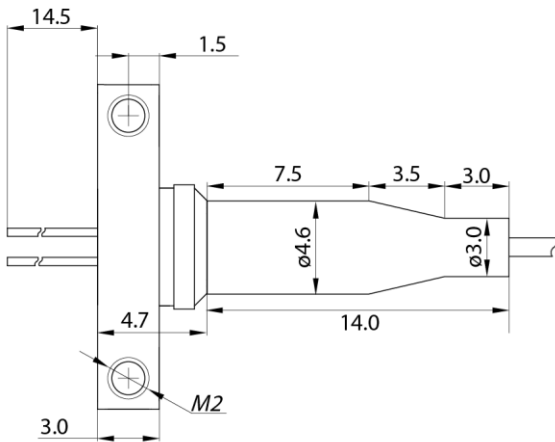

1. Case
2. LD Cathode
3. PD Anode
4. LD Anode, PD Cathode

# LDI-1310-FP-1.25G-20/100

---

Characteristics, data, materials and structures specified in this datasheet are subject to change without notice. Please refer to the latest specification before use of the products.

## Safety and handling cautions

1. Laser light is very dangerous if shot directly into human eyes. Do not look directly into the output connector aperture or through optical components such as lenses, prisms, mirrors, microscope objectives etc. Wear protective goggles.
2. Avoid smashing and burning of the module. Avoid storing and using the module in conditions where water, organic solvents or aggressive acids or bases may contact the module or where there is a possibility of exposure to corrosive gases, explosive gases, dust, salinity or other harsh conditions. The module should be disposed as special industrial waste.
3. Exceeding absolute maximal ratings even for a short time can cause permanent damage of the module.
4. The module is sensitive to and can be broken by ESD (static electricity).

## Conflict Minerals Policy Statement

LasersCom LLC achieves business objectives and customer needs with social responsibility. We do not support or contribute to the violence and human rights violations associated with the mining of conflict minerals coming from Conflict Regions according to US "Dodd-Frank Act". When possible, our suppliers' conflict mineral statements are reviewed. We do not directly purchase Conflict Minerals from any source and do not knowingly procure any parts and products containing Conflict Minerals from Conflict Regions.

## RoHS Compliance Statement

Restriction of Hazardous Substances (RoHS) directive (Directive 2011/65/EC amended with Directive (EU) 2015/863) is the directive aimed at reducing the harmful environmental impact of waste electrical equipment by restricting the use of known dangerous substances. Based on information received from our supply sources, LasersCom LLC hereby states that the banned substances listed in the RoHS directive are not found in the parts and materials used above the threshold level listed other than exceptions approved by the European Commission.

## REACH Compliance Statement

Registration, Evaluation, Authorisation and Restriction of Chemicals (REACH) is a European Union regulation 1907/2006/EC that addresses the production and use of chemical substances, and their potential impacts on human health and the environment. Based on information received from our supply sources, LasersCom LLC hereby states compliance of the parts and materials used in manufacturing to REACH regulation. LasersCom LLC does not manufacture or import any substances or preparations as defined under REACH.