



880nm, 1mW Coaxial Laser Diode Polarization-Maintaining Fiber with FC/PC Connector



PN: RLS/880NM-1MW-PMF

- Wavelength: 880 nm
- Output Power: 1 mW
- Includes Integrated Photodiode
- Polarization-Maintaining Fiber
- Standard FC/PC Connector (Inquire for other connector options)

LASER LAB SOURCE

World Leading Products for
Laser Scientists and Engineers



880NM-1MW-PMF Product Overview

This Fabry-Perot laser is offered in a coaxial polarization-maintaining fiber-coupled package, with integrated photodiode. The laser is mounted in a heat-sink bracket that allows for multiple mounting options.

This laser is coupled to 5 μm polarization-maintaining fiber, NA 0.12, and terminated with an FC/PC connector. (Other options are available; inquire for options and details).

Proven Laser Diode Expertise

These high stability fiber coupled laser diodes are designed and manufactured to meet the most demanding R&D and industrial applications.

Proprietary design, packaging, and fiber coupling processes produce laser diodes with very high stability and low noise. Each laser diode is subject to extensive testing and burn-in before shipment to ensure the highest possible levels of quality and long term reliability.

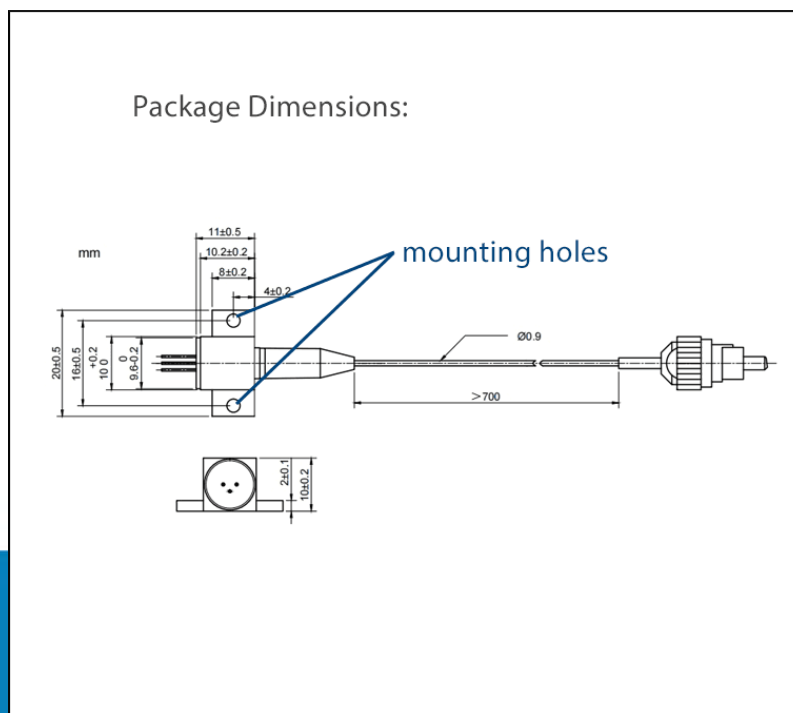



OPTICAL SPECIFICATIONS

- Output Wavelength: 880 nm \pm 10 nm
- Output Power: 1 mW
- Spectral Width (FWHM): 2.0 nm
- Wavelength Temp. Coefficient: 0.3 nm/ $^{\circ}$ C
- Beam Type: Gaussian Beam
- Laser Type: Fabry-Perot
- Includes Integrated Photodiode
- PD Current: 0.3 mA

FIBER SPECIFICATIONS

- Fiber Type: Polarization Maintaining Fiber
- Polarization Extinction Ratio: 15 dB
- Fiber Core: 5 μ m
- N.A.: 0.12
- Fiber Length: >80 cm
- Fiber Connector: FC/PC (Other Types Available; Inquire)
- Alignment: Slow Axis Aligned to FC Key

ELECTRICAL SPECIFICATIONS

- Threshold Current: 9 mA (typ)
- Operating Current: 20 mA (typ)
- Operating Voltage: 2.0 V (typ)



LASER LAB SOURCE

world leading products for **Scientists & Engineers**

manufactured by



PRODUCT SALES AND SERVICE:

Orders for this product are fulfilled by Laser Lab Source in North America.

PRODUCT WARRANTY:

This product is sold with a full one year warranty. It is warranted to be free from defects in material and/or workmanship for a period of one year from the date of shipment. Warranty does not include customer induced damage to the product through mishandling.



Laser Lab Source, a division of Research Lab Source Inc.
670 S. Ferguson St., Suite 3
Bozeman, MT 59718 USA

Phone: 800-887-5065

www.LaserLabSource.com