

m2k-BA-1870-E0500-MMF200

Fiber Coupled High Power MIR Laser

m2k **Laser**

High-Brightness Diode-Lasers

General Description

The m2k-BA-1870-E0500-MMF200 is a mid-infrared diode laser module which is used in medical applications, illumination, materials processing or pumping of mid-infrared solid-state and disc lasers. The unique brightness and efficiency of the module is achieved by broad-area, gain guided lasers based on the (AlGaIn)(AsSb) material system, epitaxially grown on GaSb substrates. The module is designed for passive cooling and is equipped with a SMA905 connector. The module is based on the unique micro-optics technology of INGENERIC.

Output power:	500 mW
Wavelength:	1870 nm
Fiber diameter:	200 μm
Fiber NA:	0.22
Connector:	SMA905

Advantages

- high brightness
- nominal output of 500 mW
- fiber diameter 200 μ m
- fiber NA 0.22
- compact package
- passive cooling
- standard and customized connector
- optional pilot beam @ 635 nm

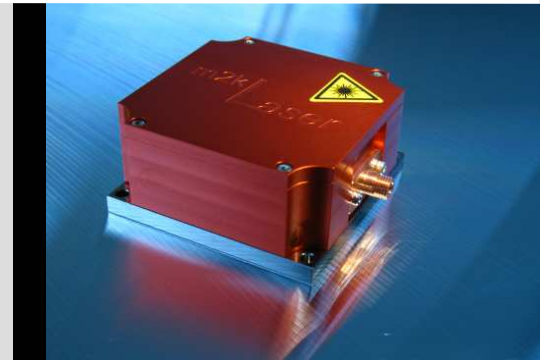

Options

- The BA-1870-E0500-MMF200 is offered optionally with pilot beam and monitor photo diode.
- The module may be delivered with the SMA905-F200.022 fiber in a length of 2.0 m.
- On request we would be pleased to develop and manufacture fiber coupled diode laser modules with customized design for your specific application.

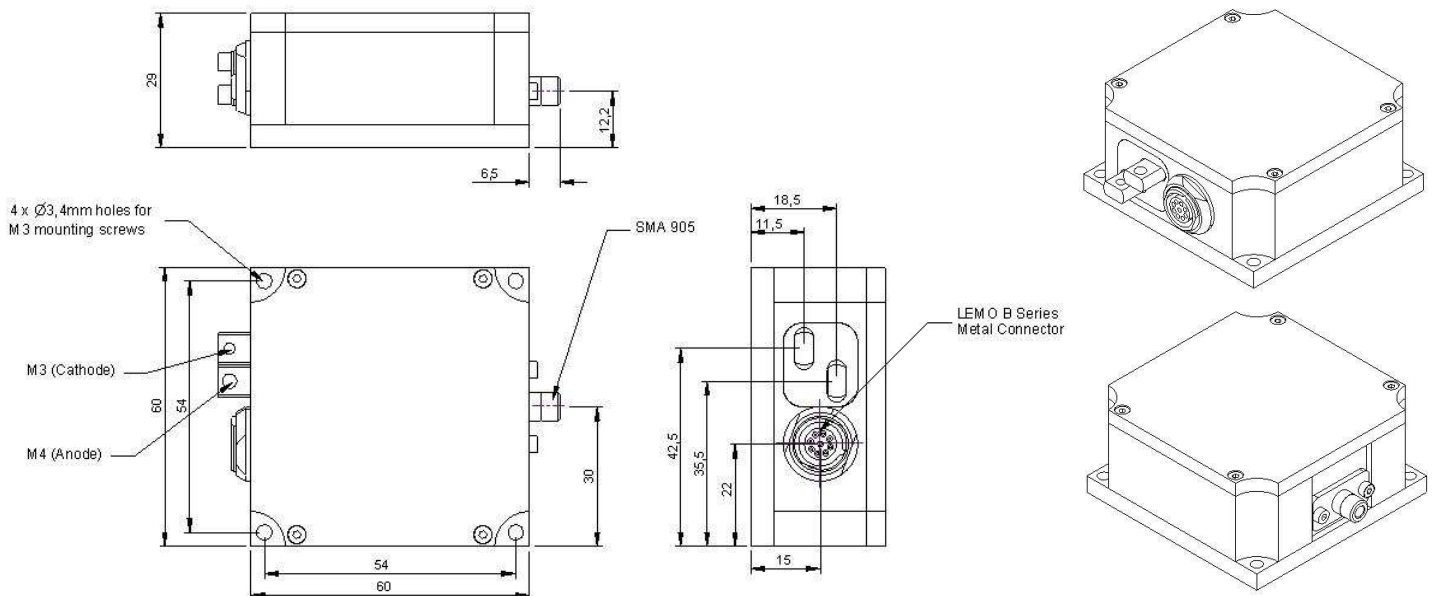

m2k-laser GmbH
Hermann Mitsch Str.36a
D-79108 Freiburg

Fon: +49 (0) 761 5158-7370
Fax: +49 (0) 761 5158-7376

Email: info@m2k-laser.de
Internet: www.m2k-laser.de

m2k-BA-1870-E0500-MMF200

Specification Data

Product		BA-1870-E0500-MMF200
Optical data		
CW - nominal output-power	mW	500
Center wavelength ¹	nm	1870
Center wavelength variation (@ 20 °C) ²	nm	±10
Spectral bandwidth (FWHM)	nm	<10
Fiber data		
Fiber core diameter	µm	200
Numerical aperture		0.22
Fiber connector		SMA905
Electrical data		
Typical operation current	A	3.8
Maximum operation current	A	4.0
Typical threshold current	A	0.5
Typical slope efficiency	W/A	> 0.1
Operation voltage	V	< 1.5
Anode / Cathode connectors		M4 (connected to case), M3
Thermal data		
Operating temperature	°C	15 ... 30
Typical base plate temperature	°C	20
Storage temperature	°C	-20 ... +60
Other specifications		
Guarantee time	month	12
Operating conditions		non-condensing atmosphere
Dimension	mm ³	60x60x30
Weight	g	300
RoHS 2002/95EC compliant		yes

Accessories (optional)		
Pilot beam		
Output power	mW	> 0.5
Wavelength	nm	635
Typical voltage	V	4
Typical current	mA	< 35
Monitor diode		
Voltage	V	5
Signal	V	< 2
Fiber SMA905-F200.022-1870		
Core diameter	µm	200
Numerical aperture		0.22
Fiber connector		SMA905
Length ³	m	2.0

¹ Other wavelength on request

² Smaller spectral bandwidth on request

³ Different length optional

Safety

This is a laser class IV product according to IEC - Standard International Commission (Publication 825, 1993). The laser light emitted from this laser diode is invisible and/or visible and is harmful to the human eye. The safety regulations for eye and personell protection included in the IEC Standard must be observed to avoid any harm to operating personell. Avoid direct exposure and looking into the laser diode, into the collimated beam or into the fiber when it is linked to the module.

Storage and shipping

Store and ship the diode laser with shortened electrical contacts, in a clean and dry atmosphere and in a tempertaure range of 0°C to 60°C.

Operation and handling

Diode lasers are extremely sensitive to over-voltage. Take extreme precaution to avoid electrostatic charges. Precautions against spiking during switching on and off the power supply must be assured. Correct polarity of power supply must be assured. During handling personell has to wear wrist straps. Grounded work surfaces and additional antistatic techniques are mandatory during handling.

Device failure and safety hazard are caused by operation in excess of maximum ratings. Exceeding output power and temperature specification will result in accelerated device ageing.

Do not mount via any paste-like media!