

AlGaInP Visible Laser Diode

ADL-65104TR

6-2D-LD65-020_Rev.00

★650nm 10mW 70°C Low Current Operation

• Features

1. High temperature operation
2. Low current operation

• Applications

1. Laser levelers
2. Industrial laser markers / measuring instruments
3. Bar code readers

• Absolute maximum ratings

Parameter	Symbol	Condition	Rating	Unit
Light output power	P_O	CW	10	mW
Reverse voltage (LD)	V_{RL}	-	2	V
Reverse voltage (PD)	V_{RD}	-	30	V
Forward current (PD)	I_{FD}	-	10	mA
Case temperature	T_C	-	-10~+70	°C
Storage temperature	T_S	-	-40~+85	°C

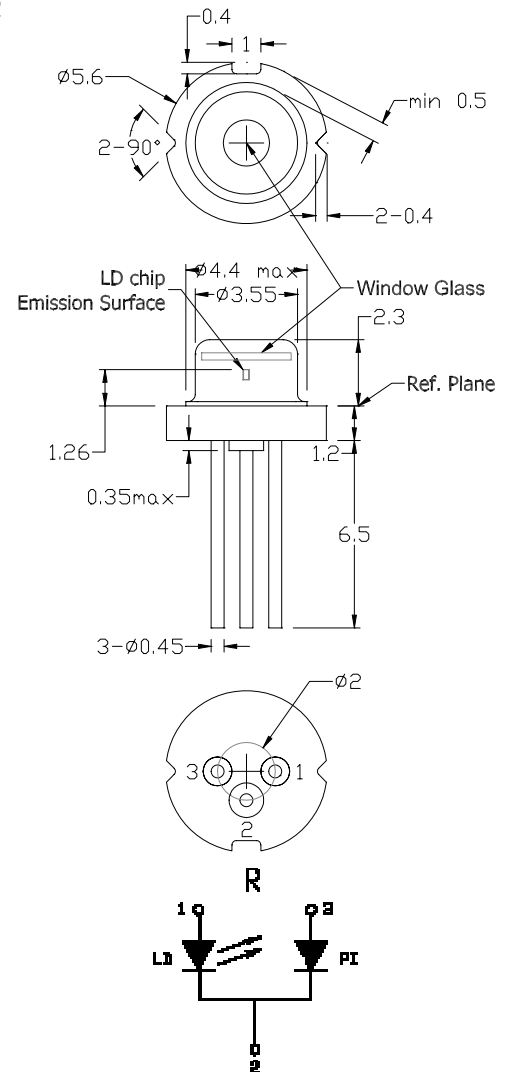

• Electrical and optical characteristics ($T_c=25^\circ\text{C}$)

Parameter	Symbol	Min.	Typ.	Max.	Unit	Conditions
Peak wavelength	λ	645	655	660	nm	$P_o=10\text{mW}$
Threshold current	I_{th}	-	20	25	mA	
Operating current	I_{op}	-	32	40	mA	$P_o=10\text{mW}$
Operating voltage	V_{op}	-	2.2	2.6	V	$P_o=10\text{mW}$
Differential efficiency	η	0.6	0.9	1.0	mW/mA	$P_o=7-10$
Monitor current	I_m	0.1	0.3	0.45	mA	$P_o=10\text{mW}, V_{RD}=5\text{V}$
Parallel divergence angle	$\theta_{ }$	6	9	12	deg	
Perpendicular divergence angle	θ_{\perp}	25	28	32	deg	
Parallel FFP deviation angle	$\Delta\theta_{ }$	-3	0	+3	deg	$P_o=10\text{mW}$
Perpendicular FFP deviation angle	$\Delta\theta_{\perp}$	-3	0	+3	deg	
Emission point accuracy	$\Delta x \Delta y \Delta z$	-80	0	+80	um	

• Precautions

- * Do not operate the device above maximum ratings. Doing so may cause unexpected and permanent damage to the device.
- * Take precautions to avoid electrostatic discharge and/or momentary power spikes. A change in the characteristics of the laser or premature failure may result.
- * Proper heat sinking of the device assures stability and lifetime. Always ensure that maximum operating temperatures are not exceeded.
- * Observing visible or invisible laser beams with the human eye directly, or indirectly, can cause permanent damage. Use a camera to observe the laser.
- * No laser device should be used in any application or situation where life or property is at risk in event of device failure.
- * Specifications are subject to change without notice. Ensure that you have the latest specification by contacting us prior to purchase or use of the product

* For reference only. Contents above are subject to change without notice.

Arima
LASERS

AlGaInP Visible Laser Diode

ADL-65104TR

6-2D-LD65-020_Rev.00

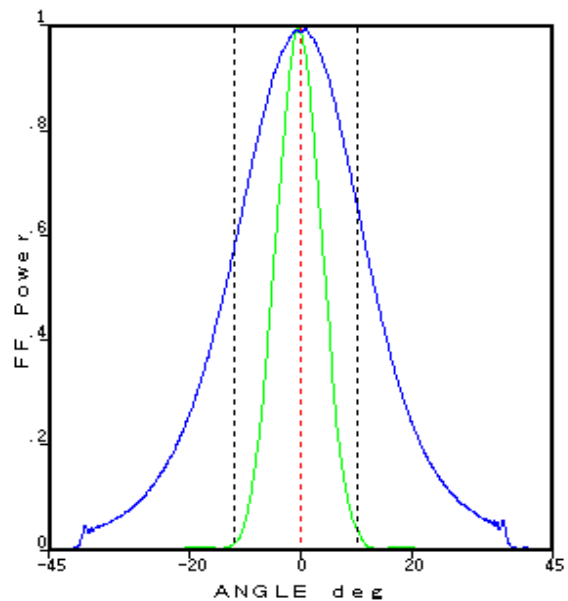
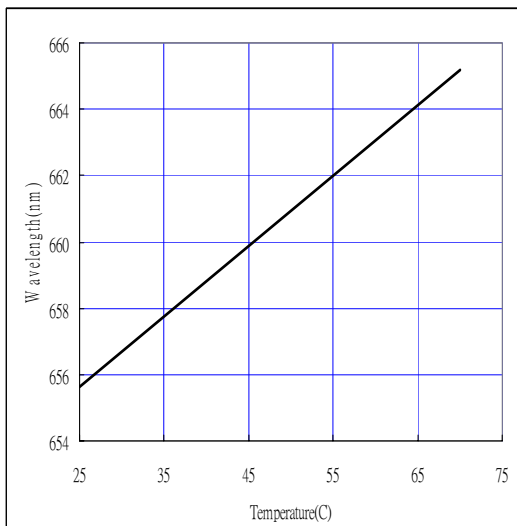
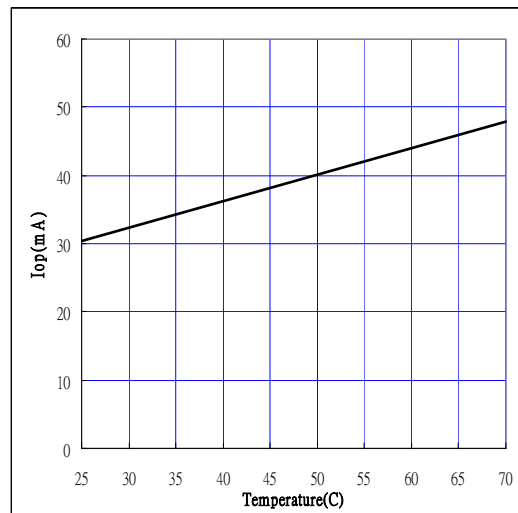
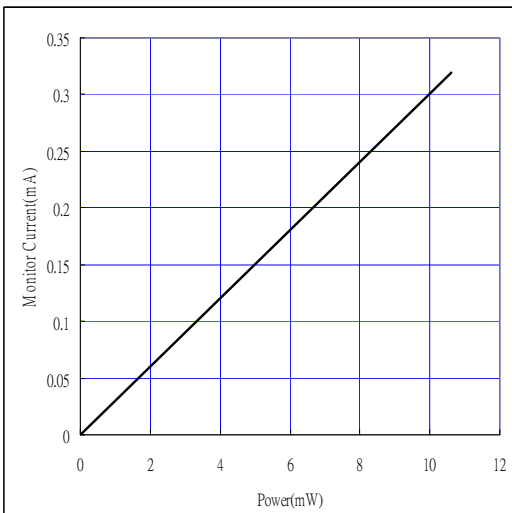
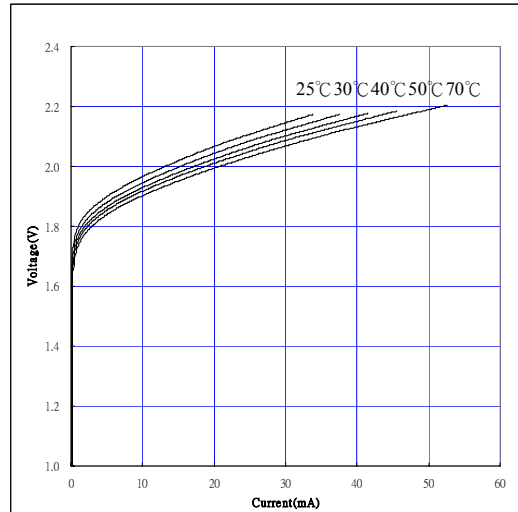
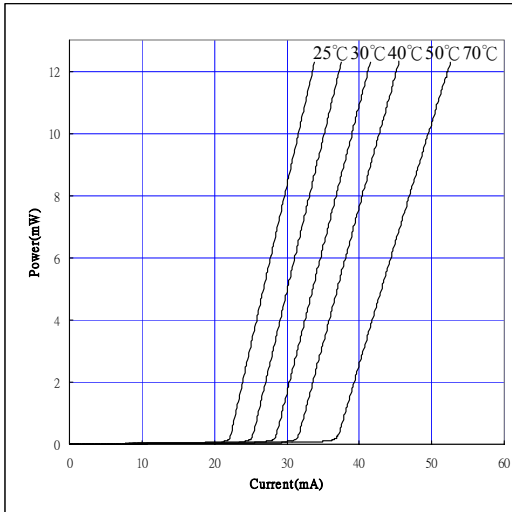

* For reference only. Contents above are subject to change without notice.